

**SONY**SONY  
Digital HD Video Camera Recorder

GB

# Digital HD Video Camera Recorder

## Operating Guide

Before operating the unit, please read this manual thoroughly,  
and retain it for future reference

The supplied CD-ROM includes Operating Guide for the HVR-V1 series.  
(Japanese, English, French, German, Italian, Spanish, and Simplified Chinese  
versions).  
For more details, see "Using the CD-ROM Manual" on page 18.

**HDV**  
HDV 1080i**DVCAM**<sup>TM</sup>Mini **DV** Digital  
Video  
Cassette**InfoLITHIUM**<sup>TM</sup> **L**  
SERIES**MEMORY STICK**<sup>TM</sup>**HDMI****HVR-V1E/V1P**

© 2006 Sony Corporation

<http://www.sony.net/>

**eco**  
info Printed on 70% or more recycled paper  
using VOC (Volatile Organic Compound)  
-free vegetable oil based ink.

Printed in Japan



## WARNING

To reduce fire or shock hazard, do not expose the unit to rain or moisture.

## For Customers in the U.S.A.

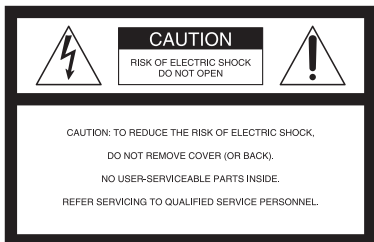

This symbol is intended to alert the user to the presence of uninsulated “dangerous voltage” within the product’s enclosure that may be of sufficient magnitude to constitute a risk of electric shock to persons.



This symbol is intended to alert the user to the presence of important operating and maintenance (servicing) instructions in the literature accompanying the appliance.

# IMPORTANT SAFEGUARDS

For your protection, please read these safety instructions completely before operating the appliance, and keep this manual for future reference.

Carefully observe all warnings, precautions and instructions on the appliance, or the one described in the operating instructions and adhere to them.

## Use

### Power Sources

This set should be operated only from the type of power source indicated on the marking label. If you are not sure of the type of electrical power supplied to your home, consult your dealer or local power company. For those sets designed to operate from battery power, or other sources, refer to the operating instructions.

### Polarization

This set may be equipped with a polarized ac power cord plug (a plug having one blade wider than the other).

This plug will fit into the power outlet only one way. This is a safety feature. If you are unable to insert the plug fully into the outlet, try reversing the plug. If the plug should still fail to fit, contact your electrician to have a suitable outlet installed. Do not defeat the safety purpose of the polarized plug by forcing it in.

### Overloading

Do not overload wall outlets, extension cords or convenience receptacles beyond their capacity, since this can result in fire or electric shock.

### Object and Liquid Entry

Never push objects of any kind into the set through openings as they may touch dangerous voltage points or short out parts that could result in a fire or electric shock. Never spill liquid of any kind on the set.

### Attachments

Do not use attachments not recommended by the manufacturer, as they may cause hazards.

## Cleaning

Unplug the set from the wall outlet before cleaning or polishing it. Do not use liquid cleaners or aerosol cleaners. Use a cloth lightly dampened with water for cleaning the exterior of the set.

## Installation

### Water and Moisture

Do not use power-line operated sets near water – for example, near a bathtub, washbowl, kitchen sink, or laundry tub, in a wet basement, or near a swimming pool, etc.

### Power-Cord Protection

Route the power cord so that it is not likely to be walked on or pinched by items placed upon or against them, paying particular attention to the plugs, receptacles, and the point where the cord exits from the appliance.

### Accessories

Do not place the set on an unstable cart, stand, tripod, bracket, or table. The set may fall, causing serious injury to a child or an adult, and serious damage to the set. Use only a cart, stand, tripod, bracket, or table recommended by the manufacturer.

### Ventilation

The slots and openings in the cabinet are provided for necessary ventilation. To ensure reliable operation of the set, and to protect it from overheating, these slots and openings must never be blocked or covered.

- Never cover the slots and openings with a cloth or other materials.
- Never block the slots and openings by placing the set on a bed, sofa, rug, or other similar surface.
- Never place the set in a confined space, such as a bookcase, or built-in cabinet, unless proper ventilation is provided.
- Do not place the set near or over a radiator or heat register, or where it is exposed to direct sunlight.

## IMPORTANT SAFEGUARDS (Continued)

### Lightning

For added protection for this set during a lightning storm, or when it is left unattended and unused for long periods of time, unplug it from the wall outlet and disconnect the antenna or cable system. This will prevent damage to the set due to lightning and power-line surges.

## Service

### Damage Requiring Service

Unplug the set from the wall outlet and refer servicing to qualified service personnel under the following conditions:

- When the power cord or plug is damaged or frayed.
- If liquid has been spilled or objects have fallen into the set.
- If the set has been exposed to rain or water.
- If the set has been subject to excessive shock by being dropped, or the cabinet has been damaged.
- If the set does not operate normally when following the operating instructions. Adjust only those controls that are specified in the operating instructions. Improper adjustment of other controls may result in damage and will often require extensive work by a qualified technician to restore the set to normal operation.
- When the set exhibits a distinct change in performance – this indicates a need for service.

### Servicing

Do not attempt to service the set yourself as opening or removing covers may expose you to dangerous voltage or other hazards.

Refer all servicing to qualified service personnel.

### Replacement parts

When replacement parts are required, be sure the service technician has used replacement parts specified by the manufacturer that have the same characteristics as the original parts.

Unauthorized substitutions may result in fire, electric shock, or other hazards.

### Safety Check

Upon completion of any service or repairs to the set, ask the service technician to perform routine safety checks (as specified by the manufacturer) to determine that the set is in safe operating condition.

# Read this first

## English

Before operating the unit, please read this manual thoroughly, and retain it for future reference.

### CAUTION

**Replace the battery with the specified type only. Otherwise, fire or injury may result.**



Excessive sound pressure from earphones and headphones can cause hearing loss.

Do not expose the batteries to excessive heat such as sunshine, fire or the like.

### FOR CUSTOMERS IN THE UNITED KINGDOM

#### NOTICE ON THE SUPPLIED AC ADAPTOR

A moulded plug complying with BS1363 is fitted to this equipment for your safety and convenience.

Should the fuse in the plug supplied need to be replaced, a fuse of the same rating as the supplied one and approved by ASTA or BSI to BS1362 (i.e., marked with  or  mark) must be used.

If the plug supplied with this equipment has a detachable fuse cover, be sure to attach the fuse cover after you change the fuse. Never use the plug without the fuse cover. If you should lose the fuse cover, please contact your nearest Sony service station.

### FOR CUSTOMERS IN EUROPE

#### ATTENTION

The electromagnetic fields at the specific frequencies may influence the picture and sound of this camcorder.

#### HVR-V1E only

This product with the CE marking complies with both the EMC directive and the Low

Voltage Directive issued by the Commission of the European Community. Compliance with these directives implies conformity to the following European standards:

- EN60065:Product Safety (supplied AC Adaptor only)
- EN55103-1:Electromagnetic Interference (Emission)
- EN55103-2:Electromagnetic Susceptibility (Immunity)

This product is intended for use in the following Electromagnetic Environment(s):E1 (residential), E2 (commercial and light industrial), E3 (urban outdoors) and E4 (controlled EMC environment ex. TV studio).

#### Notice for the customer in the countries applying EU Directives

The manufacturer of this product is Sony Corporation, 1-7-1 Konan Minato-ku Tokyo, 108-0075 Japan. The Authorized Representative for EMC and product safety is Sony Deutschland GmbH, Hedelfinger Strasse 61,70327 Stuttgart, Germany. For any service or guarantee matters, please refer to the addresses given in separate service or guarantee documents.

#### HVR-V1E only



**Disposal of Waste Electrical and Electronic Equipment for business use (Applicable in the European Union and other European countries with separate collection systems)**

This symbol on the product or on its packaging indicates that this product shall not be treated as household waste. Instead it shall be handed over to the applicable take-back scheme for the recycling of electrical and electronic equipment. By ensuring this product is disposed of correctly, you will

## Read this first (Continued)

help prevent potential negative consequences for the environment and human health, which could otherwise be caused by inappropriate waste handling of this product.

The recycling of materials will help to conserve natural resources. For more detailed information about recycling of this product, please contact your local Sony office or visit Sony Europe's web site for business customers:  
<http://www.sonybiz.net/environment>

### For the customers in the Nederland Voor de klanten in Nederland

Dit apparaat bevat een vast ingebouwde batterij die niet vervangen hoeft te worden tijdens de levensduur van het apparaat.

Raadpleeg uw leverancier indien de batterij toch vervangen moet worden.

De batterij mag alleen vervangen worden door vakbekwaam servicepersoneel.

Gooi de batterij niet weg maar lever deze in als klein chemisch afval (KCA).

Lever het apparaat aan het einde van de levensduur in voor recycling, de batterij zal dan op correcte wijze verwerkt worden.



### For customers in the U.S.A. and CANADA

#### HVR-V1P only RECYCLING LITHIUM-ION BATTERIES

Lithium-Ion batteries are recyclable. You can help preserve our environment by returning your used rechargeable batteries to the collection and recycling location nearest you.

For more information regarding recycling of rechargeable batteries, call toll free 1-800-822-8837, or visit <http://www.rbrc.org/>



Caution: Do not handle damaged or leaking Lithium-Ion batteries.

### Owner's Record

The model and serial numbers are located on the bottom. Record the serial number in the space provided below. Refer to these numbers whenever you call upon your Sony dealer regarding this product.

Model No. HVR-

Serial No.

Model No. AC-

No.

### For customers in the U.S.A.

If you have any questions about this product, you may call:  
Sony Customer Information Center 1-800-686-SONY (7669).

The number below is for the FCC related matters only.

### Regulatory Information

#### Declaration of Conformity

Trade Name: SONY

Model No.: HVR-V1P

Responsible Party: Sony Electronics Inc.

Address: 16530 Via Esprillo, San Diego, CA 92127 U.S.A.

Telephone Number: 858-942-2230

This device complies with Part 15 of the FCC Rules.

Operation is subject to the following two conditions:

- (1) This device may not cause harmful interference, and (2) this device must accept any interference received, including interference that may cause undesired operation.

### CAUTION

You are cautioned that any changes or modifications not expressly approved in this manual could void your authority to operate this equipment.

### Note

This equipment has been tested and found to comply with the limits for a Class B digital device, pursuant to Part 15 of the FCC Rules.

These limits are designed to provide reasonable protection against harmful interference in a residential installation. This equipment generates, uses, and can radiate radio frequency energy and, if not installed and used in accordance with the instructions, may cause harmful interference to radio communications.

However, there is no guarantee that interference will not occur in a particular installation. If this equipment does cause harmful interference to radio or television reception, which can be determined by turning the equipment off and on, the user is encouraged to try to correct the interference by one or more of the following measures:

- Reorient or relocate the receiving antenna.
- Increase the separation between the equipment and receiver.
- Connect the equipment into an outlet on a circuit different from that to which the receiver is connected.
- Consult the dealer or an experienced radio/TV technician for help.

The supplied interface cable must be used with the equipment in order to comply with the limits for a digital device pursuant to Subpart B of Part 15 of FCC Rules.

### **For the State of California, USA only**

Perchlorate Material - special handling may apply, See

[www.dtsc.ca.gov/hazardouswaste/perchlorate](http://www.dtsc.ca.gov/hazardouswaste/perchlorate)

Perchlorate Material: Lithium battery contains perchlorate.

## **Deutsch**

### **WARNUNG**

**Um Feuer- oder Berührungsgefahr zu verringern, setzen Sie das Gerät weder Regen noch Feuchtigkeit aus.**

Ein zu großer Schalldruck von Ohrhörern oder Kopfhörern kann zu Hörverlusten führen.

Schützen Sie Akkus und Batterien vor übermäßiger Hitze, wie z. B. direktem Sonnenlicht, Feuer o. Ä.

### **VORSICHT**

- Auch wenn der Camcorder ausgeschaltet ist, wird er immer noch mit Netzstrom versorgt, solange er über ein Netzteil an eine Netzsteckdose angeschlossen ist.

### **ACHTUNG**

**Ersetzen Sie die Batterie bzw. den Akku ausschließlich durch eine Batterie bzw. Einen Akku des angegebenen Typs. Andernfalls besteht Feuer- oder Verletzungsgefahr.**

- Schließen Sie das Netzteil an eine nahe gelegene Netzsteckdose an. Trennen Sie das Netzteil umgehend von der Netzsteckdose, wenn es beim Betrieb des Camcorders zu einer Fehlfunktion kommt.

### **FÜR KUNDEN IN EUROPA**

### **ACHTUNG**

Die elektromagnetischen Felder bei den speziellen Frequenzen können Bild und Ton dieses Gerätes beeinflussen.

### **nur HVR-V1E**

Dieses Produkt mit dem CE-Zeichen entspricht der von der Kommission der Europäischen Gemeinschaft erlassenen EMV-Direktive und der Niederspannungsdirektive.

Die Erfüllung dieser Richtlinien bedeutet die Übereinstimmung mit den folgenden europäischen Normen:

- EN60065: Gerätesicherheit (nur mitgeliefertes Netzteil)

## Read this first (Continued)

- EN55103-1: Funkstörungen von informationstechnischen Einrichtungen
- EN55103-2: Störfestigkeitseigenschaften von informationstechnischen Einrichtungen

Dieses Produkt ist für die Verwendung in folgenden elektromagnetischen Umgebungen ausgelegt: E1 (Wohnbereich), E2 (Geschäfts- und Gewerbebereich sowie Kleinbetriebe), E3 (städtischer Außenbereich) und E4 (kontrollierte EMV-Umgebung, z. B. Fernsehstudio)

### Einschaltstoßstrom

Einschaltstoßstrom entsprechend der EU-Richtlinie EN55103-1 gemessen: 5 A (230 V)

- Verwenden Sie das Netzteil nicht, wenn nur wenig Platz vorhanden ist, z.B. zwischen einer Wand und Möbelstücken.

### Hinweis für Kunden in Ländern, in denen EU-Richtlinien gelten

Der Hersteller dieses Produkts ist Sony Corporation, 1-7-1 Konan Minato-ku Tokyo, 108-0075, Japan. Autorisierter Vertreter für EMV und Produktsicherheit ist die Sony Deutschland GmbH, Hedelfinger Strasse 61, 70327 Stuttgart, Deutschland. Für Fragen im Zusammenhang mit Kundendienst oder Garantie wenden Sie sich bitte an die in den separaten Kundendienst- oder Garantieunterlagen genannten Adressen.

### nur HVR-V1E



**Entsorgung von als Industriemüll anfallenden elektrischen und elektronischen Geräten (anzuwenden in den Ländern der Europäischen Union und anderen europäischen Ländern mit einem separaten Sammelsystem für diese Geräte)**

Das Symbol auf dem Produkt oder seiner Verpackung weist darauf hin, dass dieses Produkt nicht als normaler Haushaltsabfall zu behandeln ist, sondern im Rahmen des entsprechenden Rücknahmeprogramms für das Recycling von elektrischen und elektronischen Geräten

abgegeben werden muss. Durch Ihren Beitrag zum korrekten Entsorgen dieses Produkts schützen Sie die Umwelt und die Gesundheit Ihrer Mitmenschen. Umwelt und Gesundheit werden durch falsches Entsorgen gefährdet. Materialrecycling hilft, den Verbrauch von Rohstoffen zu verringern. Weitere Informationen über das Recycling dieses Produkts erhalten Sie von der örtlichen Sony-Niederlassung oder auf der für Firmenkunden eingerichteten Website von Sony Europe:

<http://www.sonybiz.net/environment>

## Für Kunden in Deutschland

Entsorgungshinweis: Bitte werfen Sie nur entladene Batterien in die Sammelboxen beim Handel oder den Kommunen.

Entladen sind Batterien in der Regel dann, wenn das Gerät abschaltet und signalisiert „Batterie leer“ oder nach längerer Gebrauchsdauer der Batterien „nicht mehr einwandfrei funktioniert“. Um sicherzugehen, kleben Sie die Batteriepole z.B. mit einem Klebestreifen ab oder geben Sie die Batterien einzeln in einen Plastikbeutel.



## Español

POR FAVOR LEA DETALLADAMENTE ESTE MANUAL DE INSTRUCCIONES ANTES DE CONECTAR Y OPERAR ESTE EQUIPO.

RECUERDE QUE UN MAL USO DE SU APARATO PODRÍA ANULAR LA GARANTÍA.

### AVISO

**Para reducir el riesgo de incendio o descarga eléctrica, no exponga la unidad a la lluvia ni a la humedad.**

Una presión acústica excesiva de los auriculares puede provocar pérdidas auditivas

No exponga las pilas a fuentes de calor excesivo como luz solar directa, fuego o similares.

### PRECAUCIÓN

- Incluso con la videocámara desconectada, ésta seguirá recibiendo alimentación de ca (corriente) mientras esté conectada a la toma de pared mediante el adaptador de ca

### PRECAUCIÓN

**Sustituya la batería únicamente por otra del tipo especificado. De lo contrario, es posible que se produzcan incendios o lesiones.**

- Utilice una toma de pared cercana al usar el adaptador de ca. Desconecte el adaptador de ca de la toma de pared inmediatamente si se produce algún fallo al utilizar la videocámara.

### PARA LOS CLIENTES DE EUROPA

### ATENCIÓN

Los campos electromagnéticos a frecuencias específicas podrán influir en la imagen y el sonido de esta unidad.

### Sólo HVR-V1E

Este producto con la marca CE cumple con la Directiva EMC y la Directiva de baja tensión emitidas por la Comisión de la Comunidad Europea.

El cumplimiento de estas directivas implica conformidad con las siguientes normas europeas:

- EN60065: Seguridad del producto

(sólo Adaptador de ca suministrado)

- EN55103-1: Interferencia electromagnética (Emisión)
- EN55103-2: Susceptibilidad electromagnética (Inmunidad)

Este producto está diseñado para su utilización en los Entornos electromagnéticos siguientes: E1 (uso residencial), E2 (uso comercial e industrial ligero), E3 (exteriores urbanos) y E4 (entorno con EMC controlada, por ejemplo un estudio de TV).

### Pico de corriente de entrada

Corriente de entrada de conmutación en caliente, medida según la norma europea EN55103-1: 5 A (230 V)

- No utilice el adaptador de ca en un lugar estrecho (por ejemplo, entre la pared y un mueble).

### Aviso para los clientes de países en los que se aplican las directivas de la UE

El fabricante de este producto es Sony Corporation, 1-7-1 Konan Minato-ku Tokyo, 108-0075, Japón. El representante autorizado en lo referente al cumplimiento de la directiva EMC y a la seguridad de los productos es Sony Deutschland GmbH, Hedelfinger Strasse 61, 70327 Stuttgart, Alemania. Para resolver cualquier asunto relacionado con el soporte técnico o la garantía, consulte las direcciones que se indican en los documentos de soporte técnico y garantía suministrados por separado.

### Sólo HVR-V1E



**Tratamiento de equipos eléctricos y electrónicos de uso comercial al final de su vida útil (aplicable en la Unión Europea y en países europeos con sistemas de recogida selectiva de residuos)**

Este símbolo en su equipo o su embalaje indica que el presente producto no puede ser tratado como residuos domésticos normales. En su lugar, deben entregarse conforme al correspondiente plan de recogida para el reciclaje de equipos eléctricos y electrónicos. Asegurándose de que este producto es desechado correctamente, Ud. ayuda a prevenir las consecuencias negativas para el medio ambiente y la salud humana que podrían derivarse de la incorrecta manipulación de este producto. El reciclaje de materiales ayuda a conservar las reservas naturales. Para obtener información detallada sobre el reciclaje de este producto, contacte con su oficina local de Sony o visite la página Web europea de Sony para empresas:

<http://www.sonybiz.net/environment>

### Français

#### AVERTISSEMENT

**Afin de réduire les risques d'incendie ou de décharge électrique, n'exposez pas cet appareil à la pluie ou à l'humidité.**

Une pression sonore excessive des écouteurs ou du casque peut provoquer des pertes d'audition.

N'exposez pas les piles à une chaleur excessive comme à la lumière du soleil, au feu ou à d'autres sources de chaleur.

#### PRECAUTION

- Même si votre caméscope est mis hors tension, l'appareil est toujours alimenté tant qu'il est raccordé à la prise secteur via l'adaptateur.

#### ATTENTION

**Remplacez la batterie par une batterie correspondant au type spécifié uniquement. Sinon vous risquez de provoquer un incendie ou des blessures.**

- Branchez l'adaptateur secteur sur la prise de courant la plus proche. Débranchez immédiatement l'adaptateur secteur de la prise de courant si un problème de fonctionnement se produit pendant l'utilisation du caméscope.

#### POUR LES CLIENTS RESIDANT EN EUROPE

#### ATTENTION

Le champ électromagnétique à des fréquences particulières peut avoir une incidence sur l'image et le son de cet appareil.

#### HVR-V1E uniquement

Ce produit portant la marque CE est conforme aux dispositions de la directive sur la Compatibilité électromagnétique (CEM) et de la directive Basse Tension émises par la Commission de la Communauté Européenne.

La conformité à ces directives implique la conformité aux normes européennes suivantes:

- EN60065 : Sécurité des produits (adaptateur secteur fourni uniquement)

- EN55103-1 : Interférences (émissions) électromagnétiques
- EN55103-2 : Susceptibilité (immunité) électromagnétique

Ce produit est destiné à une utilisation dans les environnements électromagnétiques suivants : E1 (résidentiel), E2 (commercial et industrie légère), E3 (intérieur urbain) et E4 (environnement EMC contrôlé, par exemple studio de télévision).

#### Courant d'entrée de pointe

Courant d'entrée de commutation, mesuré conformément à la norme européenne EN55103-1: 5 A (230 V)

- N'utilisez pas l'adaptateur CA dans un espace étroit (entre un mur et un meuble par exemple).

#### Avis aux consommateurs des pays appliquant les Directives UE

Le fabricant de ce produit est Sony Corporation, 1-7-1 Konan Minato-ku Tokyo, 108-0075 Japon. Le représentant agréé pour la compatibilité électromagnétique et la sécurité du produit est Sony Deutschland GmbH, Hedelfinger Strasse 61, 70327 Stuttgart, Allemagne. Pour toute question relative à la garantie ou aux réparations, reportez-vous à l'adresse que vous trouverez dans les documents ci-joints, relatifs à la garantie et aux réparations.

#### HVR-V1E uniquement



**Élimination des appareils électriques et électroniques professionnels en fin de vie (Applicable dans les pays de l'Union Européenne et aux autres pays européens disposant de systèmes de collecte sélective)**

Ce symbole, apposé sur le produit ou son emballage, indique que ce produit ne doit pas être traité avec les déchets ménagers. Il doit être déposé dans un point de collecte spécialisés dans le recyclage des équipements électriques et électroniques. En s'assurant que ce produit est bien mis au rebut de manière appropriée, vous aiderez à prévenir les conséquences négatives potentielles pour l'environnement et la santé humaine. Le recyclage des matériaux aidera à conserver les ressources naturelles. Pour toute information supplémentaire concernant le recyclage de ce produit, contactez votre centre Sony local ou consultez le site web de Sony pour l'Europe destiné aux professionnels : <http://www.sonybiz.net/environment>

**AVVERTENZA**

**Per ridurre il pericolo di incendi o scosse elettriche, non esporre l'apparecchio alla pioggia o all'umidità.**

È possibile che un'eccessiva pressione audio emessa dagli auricolari e dalle cuffie causi la perdita dell'udito.

Non esporre le pile a fonti di calore eccessivo, quali luce solare, fuoco o simili.

**PRECAUZIONE**

- Anche se disattivata, la videocamera continua a ricevere alimentazione CA (corrente domestica) fintanto che rimane collegata ad una presa di rete mediante l'alimentatore CA.

**AVVERTENZA**

**Sostituire la batteria esclusivamente con una del tipo specificato. Diversamente, si potrebbero causare incendi o incidenti.**

- Collegare l'alimentatore CA alla presa di rete più vicina. In caso di problemi di funzionamento durante l'uso della videocamera, scollegare immediatamente l'alimentatore CA dalla presa di rete.

**PER I CLIENTI IN EUROPA****ATTENZIONE**

Il campo elettromagnetico alle frequenze specifiche può influenzare l'immagine e il suono di questa unità.

**solo HVR-V1E**

Il presente prodotto dotato del marchio CE è conforme alla Direttiva EMC e alla Direttiva Bassa Tensione emesse dalla Commissione della Comunità Europea.

Il rispetto di tali direttive implica la conformità ai seguenti standard europei:

- EN60065: Sicurezza dei prodotti (solo per l'alimentatore CA in dotazione)
- EN55103-1: Interferenze elettromagnetiche (emissione)

- EN55103-2: Suscettibilità elettromagnetica (immunità)

Questo prodotto è stato progettato per essere utilizzato nei seguenti ambienti elettromagnetici: E1 (residenziali), E2 (commerciali e industria leggera), E3 (esterni urbani) ed E4 (ambienti EMC controllati, ad es. studi televisivi).

**Corrente di punta di entrata di picco**

Corrente di punta di entrata hot-switch, misurata in base allo standard europeo EN55103-1: 5 A (230 V)

- Non posizionare l'alimentatore CA in spazi ristretti, ad esempio tra un muro e un mobile.

**Avviso per i clienti residenti nei paesi che applicano le direttive UE**

Questo prodotto è realizzato da Sony Corporation, 1-7-1 Konan Minato-ku Tokyo, 108-0075 Giappone. Il Rappresentante autorizzato per la conformità alle direttive EMC e per la sicurezza dei prodotti è Sony Deutschland GmbH, Hedelfinger Strasse 61, 70327 Stuttgart, Germania. Per qualsiasi questione relativa all'assistenza o alla garanzia, consultare gli indirizzi forniti a parte nei relativi documenti.

**solo HVR-V1E**

**Smaltimento del dispositivo elettrico ed elettronico per uso aziendale a fine vita (applicabile in tutti i paesi dell'Unione Europea e in quelli con sistema di raccolta differenziata)**

Questo simbolo sul prodotto o sulla confezione indica che il prodotto non deve essere considerato come un normale rifiuto domestico, ma deve essere consegnato presso il centro di raccolta appropriato per il riciclaggio di apparecchiature elettriche ed elettroniche. Assicurandovi che questo prodotto sia smaltito correttamente, voi contribuirete a prevenire potenziali conseguenze negative per l'ambiente e per la salute che potrebbero altrimenti essere causate dal suo smaltimento inadeguato. Il riciclaggio dei materiali aiuta a conservare le risorse naturali. Per ulteriori informazioni sul riciclaggio di questo prodotto, contattare l'ufficio Sony locale oppure visitare il sito Web europeo di Sony per i clienti aziendali all'indirizzo:

<http://www.sonybiz.net/environment>

### Notes on use

#### Types of cassette you can use in your camcorder

Your camcorder is capable of recording in HDV, DVCAM and DV formats.

When recording in HDV/DV format, it is recommended to use mini DV cassettes.

When recording in DVCAM format, it is recommended to use mini DVCAM cassettes.

Your camcorder is not compatible with the Cassette Memory function (p. 121).

#### The HDV standards

- Digital high-definition (HD) video signals are recorded and played back on a DV format cassette.
- HDV signals are compressed in MPEG2 format, which is adopted in BS (broadcast satellite) digital and terrestrial digital HDTV broadcastings and in Blu-ray disc recorders.

#### Types of “Memory Stick” you can use in your camcorder

You can use “Memory Stick Duo” marked with MEMORY STICK DUO or MEMORY STICK PRO DUO (p. 125).

“Memory Stick Duo”  
(This size can be used with your camcorder.)



“Memory Stick”  
(You cannot use it in your camcorder.)



#### Notes

- You cannot use any type of memory card except “Memory Stick Duo.”
- “Memory Stick PRO” and “Memory Stick PRO Duo” can be used only with “Memory Stick PRO” compatible equipment.
- Do not attach a label or the like on a “Memory Stick Duo” or a Memory Stick Duo Adaptor.

#### When using a “Memory Stick Duo” with “Memory Stick” compatible equipment

Be sure to insert the “Memory Stick Duo” into the Memory Stick Duo Adaptor.

Memory Stick Duo Adaptor



#### Using the camcorder

- Do not hold the camcorder by the following part.

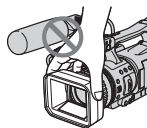

Lens hood

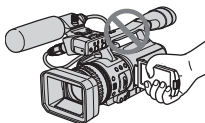

LCD panel

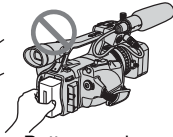

Battery pack

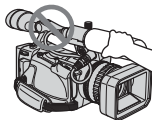

Microphone

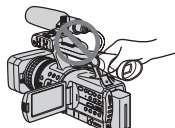

Viewfinder

## Notes

- The camcorder is not dustproof, dripproof or waterproof.  
See “Maintenance and precautions” (p. 130).
- Before connecting your camcorder to another device with an HDMI cable, component video cable, USB or i.LINK cable, be sure to insert the connector plug the correct way, and not forcibly to avoid damaging the terminal, or cause a malfunction of your camcorder.

## About menu items, LCD panel, viewfinder, and lens

- A menu item that is grayed out is not available under the current recording or playback conditions.
- The LCD screen and the viewfinder are manufactured using extremely high-precision technology, so over 99.99% of the pixels are operational for effective use. However, there may be some tiny black points and/or bright points (white, red, blue, or green in color) that appear constantly on the LCD screen and the viewfinder. These points are normal results of the manufacturing process and do not affect the recording in any way.

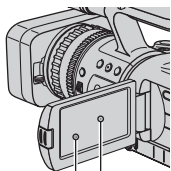

## Do not expose your camcorder's viewfinder, lens, or LCD screen to the sun or strong light source for extended periods.

- Intense light sources, especially the sun will converge on the viewfinder or lens and damage the internal parts of your

camcorder. Avoid sunlight or other strong light sources when storing your camcorder. Protect this device by always closing the lens cover or by placing it in its bag when not in use.

## On recording

- Before starting to record, test the recording function to make sure the picture and sound are recorded without any problems.
- Compensation for the contents of recordings cannot be provided, even if recording or playback is not possible due to a malfunction of the camcorder, storage media, etc.
- TV color systems differ depending on the countries/regions. To view your recordings on a TV, you need a PAL system-based TV.
- Television programs, films, video tapes, and other materials may be copyrighted. Unauthorized recording of such materials may be contrary to the copyright laws.

## On playing back HDV tapes on other devices

A tape recorded in the HDV format cannot be played back on a device that is not compatible with the HDV format. Check the contents of tapes by playing them back on this camcorder prior to playing them back on other devices.

## Notes on the icons used in this manual

 Features available for the HDV format only.

 Features available for the DVCAM format only.

 Features available for the DV SP format only.

 This function that can be used when i.LINK cable is connected.

 This function that can be used when USB cable is connected.

## Read this first (Continued)

### About this manual

- The images of the LCD screen and the viewfinder used in this manual for illustration purposes are captured using a digital still camera, and therefore may appear different.
- The on-screen displays in each local language are used for illustrating the operating procedures. Change the screen language before using your camcorder if necessary (p. 29).
- Design and specifications of recording media and other accessories are subject to change without notice.

### About the Carl Zeiss lens

Your camcorder is equipped with a Carl Zeiss lens, which was developed jointly by Carl Zeiss, in Germany, and Sony Corporation, and produces superior images. It adopts the MTF measurement system for video cameras and offers a quality typical of a Carl Zeiss lens. Also, the lens for your camcorder is T\*<sup>\*</sup>-coated to suppress unwanted reflections and faithfully reproduce colors.

MTF= Modulation Transfer Function. The number value indicates the amount of light from a subject coming into the lens.

# Table of Contents

IMPORTANT SAFEGUARDS .....	3
Read this first .....	5
Using the CD-ROM Manual .....	18

## Getting Started

Step 1: Checking supplied items .....	19
Step 2: Attaching the supplied microphone and the lens hood with lens cover .....	20
Step 3: Charging the battery pack .....	22
Step 4: Turning the power on and holding your camcorder properly .....	25
Step 5: Adjusting the LCD panel and viewfinder .....	26
Step 6: Setting the date and time .....	28
Step 7: Inserting a tape or a "Memory Stick Duo" .....	30









## Recording/Playback

Recording .....	32
Playback .....	35
Changing the settings of your camcorder recordings .....	37
Adjusting the zoom .....	37
Adjusting the focus manually .....	38
Adjusting the EXPOSURE/IRIS .....	39
Adjusting to Natural Color (White balance) .....	43
Customizing the picture quality (Picture profile) .....	44
Adjusting the volume .....	48
Assigning the functions to the ASSIGN buttons .....	49
Focusing on a distant subject (Focus infinity) .....	50
Recording an index signal .....	50
Reviewing the most recently recorded scenes (Rec review) .....	51
Searching for the last scene of the most recent recording (End search) .....	51
Playing back the most recently recorded movies (Last scene review) .....	51
Using the Shot transition .....	52
Changing/checking the settings in your camcorder .....	54
Changing the screen .....	54
Displaying the settings in your camcorder (Status check) .....	54
Checking the remaining battery (Battery Info) .....	55

Locating a scene on a tape .....	56
Searching for a scene by date of recording (Date search) .....	56
Searching for a recording start point (Index search) .....	56
Playing the picture on a TV .....	58

## Using the Menu

<i>Using the menu items</i> .....	64
Menu items .....	66
 (CAMERA SET) menu .....	69
Settings to adjust your camcorder to the recording conditions (EXPOSURE/ IRIS/STEADYSHOT/BACK LIGHT, etc.)	
 (AUDIO SET) menu .....	75
Settings for the audio recording (DV AU. MODE/XLR SET, etc.)	
 (DISPLAY SET) menu .....	77
Display settings of the display and the viewfinder (MARKER/VF B.LIGHT/ DATA CODE, etc.)	
 (IN/OUT REC) menu .....	82
Recording settings, input and output settings (VCR HDV/DV/DV REC MODE/ DV WIDE REC/ DOWN CONVERT, etc.)	
 (TC/UB SET) menu .....	85
(TC PRESET/UB PRESET/TC LINK, etc.)	
 (MEMORY SET) menu .....	87
Settings for the "Memory Stick Duo" (QUALITY/ALL ERASE, etc.)	
 (OTHERS) menu .....	89
Settings while recording on a tape or other basic settings (USB SELECT/ QUICK REC/BEEP, etc.)	



## Dubbing/Editing

Dubbing to VCR, DVD/HDD device, etc. ....	92
Recording pictures from a VCR .....	96
Copying movies from tape to “Memory Stick Duo” as still images .....	98
Deleting recorded pictures from the “Memory Stick Duo” .....	99
Printing recorded images (PictBridge compliant printer) .....	100

## Using a Computer

Connecting to a computer .....	102
Copying still images to a computer .....	102
Copying movies on a tape to a computer .....	105

## Troubleshooting

Troubleshooting .....	108
Warning indicators and messages .....	117

## Additional Information

Using your camcorder abroad .....	120
HDV format and recording/playback .....	121
Compatibility of the DVCAM/DV formats .....	123
About the “Memory Stick” .....	125
About the “InfoLITHIUM” battery pack .....	127
About i.LINK .....	128
Maintenance and precautions .....	130
Specifications .....	134

## Quick Reference

Identifying parts and controls .....	138
Indicators for the LCD screen and viewfinder .....	144
Index .....	147

# Using the CD-ROM Manual

The supplied CD-ROM includes versions of the Operating Guide for the HVR-V1 series in Japanese, English, French, German, Italian, Spanish, and Simplified Chinese in PDF format.

## Preparation

The following program must be installed on your computer in order to read the Operating Guide contained on the CD-ROM.

- Adobe Reader Version 7.0 or higher

### Tip

- If Adobe Reader is not installed, you can download it from the following URL:  
<http://www.adobe.com/>

Adobe and Adobe Reader are trademarks of Adobe Systems Incorporated in the United States and/or other countries.

## Reading the CD-ROM Manual

To read the Operating Guide contained on the CD-ROM, do the following.

---

### **1** Insert the CD-ROM in your CD-ROM drive.

A cover page appears automatically in your browser.

If it does not appear automatically in the browser, double-click on the index.htm file on the CD-ROM.

---

### **2** Select and click on the Operating Guide that you want to read.

This opens the PDF file of the Operating Guide.

---

### Tip

- The files may not be displayed properly, depending on the version of Acrobat Reader. In such a case, install the latest version you can download from the URL mentioned in “Preparation” above.

# Step 1: Checking supplied items

Make sure that you have following items supplied with your camcorder.

The number in the parentheses indicates the number of that item supplied.

- The cassette tape and “Memory Stick Duo” are not included. See page 30, 121 and 125 for compatible cassettes and “Memory Stick Duo” for your camcorder.

AC Adaptor (1) (p. 22)

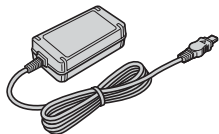

Mains lead (1) (p. 22)



Wireless Remote Commander (1) (p. 143)



A button-type lithium battery is already installed.

A/V connecting cable (1) (p. 58, 92)



Component video cable (1) (p. 58)

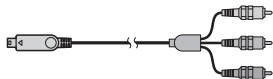

USB cable (1) (p. 100,102)

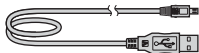

Large eyecup (1) (p. 27)



Rechargeable battery pack NP-F570 (1) (p. 22, 127)

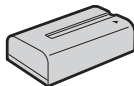

Lens hood with lens cover (1) (p. 21)

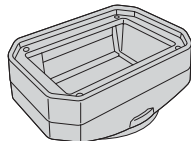

Wind Screen (1) (p. 20)

Microphone (1) (p. 20)

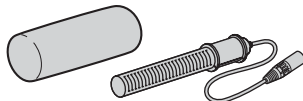

CD-ROM “Manuals for Digital HD Video Camera Recorder” (1) (p. 18)

Operating Guide (This manual) (1)

## Step 2: Attaching the supplied microphone and the lens hood with lens cover

### Attaching the supplied microphone

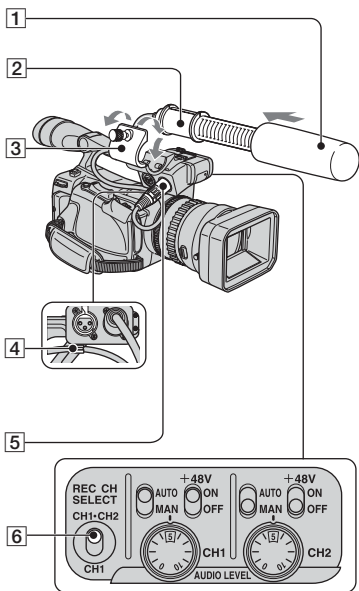

**1** Attach the wind screen **1** to the microphone **2**.

**2** Loosen the screw of the microphone holder **3** and open the cover.

**3** Place the microphone into the holder with the model name facing upward, close the cover, and tighten the screw.

**4** Connect the plug of the microphone to the INPUT1 jack **5**.

**5** Put the microphone cable into the cable holder **4**.

**6** Select the channel with the REC CH SELECT switch **6**.

The REC CH SELECT switch positions and the channels to be used at the switch positions are shown in the table below.

REC CH SELECT switch position	Input jack	Channel to be used
CH1, CH2	INPUT1	Channel1 Channel2
	INPUT2	-
CH1	INPUT1	Channel1
	INPUT2	Channel2

### 💡 Tips

- See page 48 for adjusting the volume.
- Set the +48V switch to ON when you use the supplied microphone.

## Attaching the lens hood with lens cover

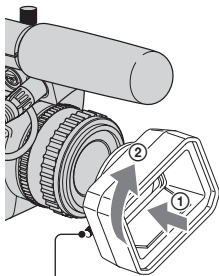

Lens hood fixing screw

Align the marks on the lens hood to those on the camcorder, and turn the lens hood in the direction of the arrow. Tighten the lens hood fixing screw.

## To remove the Lens hood with lens cover

Loosen the lens hood fixing screw and turn the lens hood in the opposite direction of the arrow in the illustration above.

### 💡 Tip

- If you attach, remove or adjust an 62mm (2 1/2in.) PL filter or MC protector, remove the lens hood.

## To open the shutter of the Lens hood with lens cover

Move the lens cover lever up and down to open or close the lens cover.

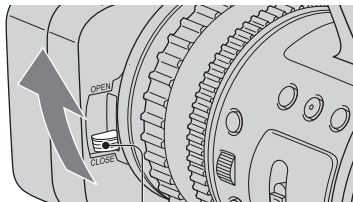

Move the lens cover lever to OPEN to open the lens cover, and move the lever to CLOSE to close the lens cover.

## Step 3: Charging the battery pack

You can charge the battery by attaching the “InfoLITHIUM” battery pack (L series) to your camcorder.

### Note

- You cannot use batteries other than the “InfoLITHIUM” battery pack (L series) (p. 127).

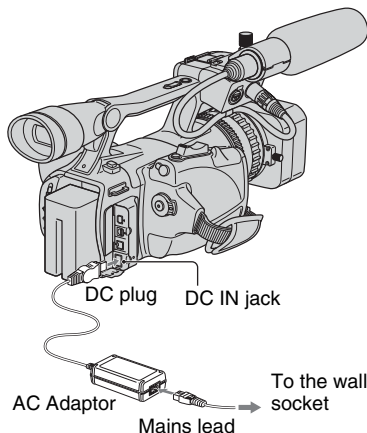

- Press the battery pack and slide it down.

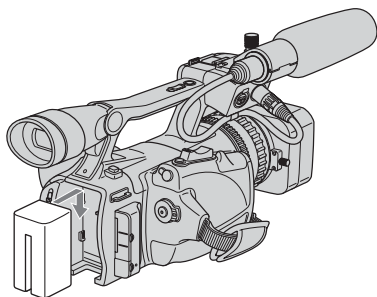

- With the ► mark on the DC plug facing the cassette compartment, connect the AC Adaptor to the DC IN jack on your camcorder.

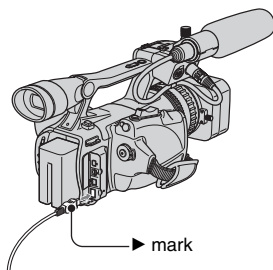

- Connect the mains lead to the AC Adaptor.

- Connect the mains lead to the wall socket.

- Set the POWER switch to OFF (CHG).

The CHARGE lamp lights up and charging starts.

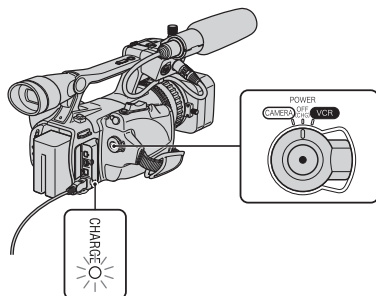

## After charging the battery

The CHARGE lamp turns off when the battery is fully charged. Disconnect the AC Adaptor from the DC IN jack.

### Tip

- You can check the remaining battery with Battery info (p. 55).

## To remove the battery pack

Slide the POWER switch to OFF (CHG). Push the BATT RELEASE (battery release) button and remove the battery pack.

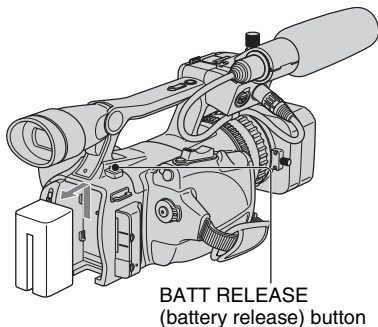

## Charging time

Approximate time (min.) required when you fully charge a fully discharged battery pack.

Battery pack	Charging time
NP-F570 (supplied)	260
NP-F770	370
NP-F970	485

### Note

- You cannot use the NP-F330 battery pack with this camcorder.

## Recording time

Approximate time (min.) available when you use a fully charged battery pack.

### Recording in the HDV format

Battery pack	Continuous recording time	Typical recording time*
NP-F570 (supplied)	135	80
	135	80
	135	80
NP-F770	280	165
	290	170
	280	165
NP-F970	415	235
	430	240
	415	235

### Recording in the DVCAM (DV) format

Battery pack	Continuous recording time	Typical recording time*
NP-F570 (supplied)	135	85
	140	90
	135	85
NP-F770	290	175
	290	175
	290	175
NP-F970	430	255
	435	260
	430	255

Top: When the LCD backlight turns on.

Middle: When the LCD backlight turns off.

Bottom: Recording time when recording with the viewfinder while the LCD panel is closed.

\* Typical recording time shows the time when you repeat recording start/stop, turning the power on/off and zooming.

## Step 3: Charging the battery pack (Continued)

### Playing time

Approximate time (min.) available when you use a fully charged battery pack.

#### HDV format pictures

Battery pack	LCD panel opened*	LCD panel closed
NP-F570 (supplied)	200	200
NP-F770	410	410
NP-F970	620	620

#### DV CAM (DV) format pictures

Battery pack	LCD panel opened*	LCD panel closed
NP-F570 (supplied)	210	210
NP-F770	435	435
NP-F970	660	660

\* When the LCD backlight turns on.

#### On the battery pack

- Before changing the battery pack, slide the POWER switch to OFF (CHG).
- The CHARGE lamp flashes during charging, or Battery Info (p. 55) will not be correctly displayed under the following conditions.
  - The battery pack is not attached correctly.
  - The battery pack is damaged.
  - The battery pack is worn-out (For Battery Info only).
- The power will not be supplied from the battery as long as the AC Adaptor is connected to the DC IN jack of your camcorder, even when the mains lead is disconnected from the wall socket.
- When attaching an optional video light, it is recommended that you use a NP-F970 battery pack.

#### On the charging/recording/playback time

- Times measured with the camcorder at 25 °C (77 °F) (10 to 30 °C (50 °F to 86 °F)) is recommended).
- The recording and playback time will be shorter when you use your camcorder in low temperatures.
- The recording and playback time will be shorter depending on the conditions under which you use your camcorder.

### Using an outside power source

You can use the AC Adaptor to obtain AC. While you are using the AC Adaptor, the battery pack will not lose its charge even when it is attached to your camcorder.

#### Connect your camcorder as shown in Step3:Charging the battery pack (p. 22).

#### On the AC Adaptor

- Use the nearby wall outlet when using the AC Adaptor. Disconnect the AC Adaptor from the wall outlet immediately if any malfunction occurs while using your camcorder.
- Do not use the AC Adaptor placed in a narrow space, such as between a wall and furniture.
- Do not short-circuit the DC plug of the AC Adaptor or battery terminal with any metallic objects. This may cause a malfunction.

#### PRECAUTION

- Even if your camcorder is turned off, AC power (house current) is still supplied to it while connected to the wall outlet via the AC Adaptor.



# Step 4: Turning the power on and holding your camcorder properly

To record or play back, slide the POWER switch to the respective direction. When using it for the first time, [CLOCK SET] screen appears (p. 28).

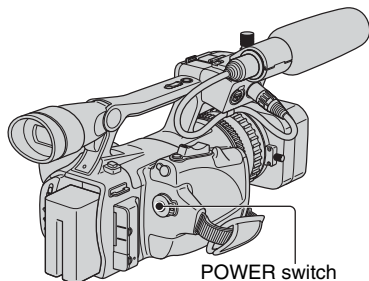

## 1 While pressing the green button, set the POWER switch.

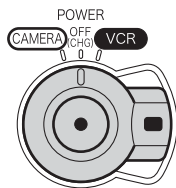

If the POWER switch is set to OFF (CHG), slide it while pressing the green button.

**CAMERA:** To record pictures.  
**VCR:** To play or edit pictures.

### Note

- After you have set the date and time ([CLOCK SET], p. 28), the next time you turn on the power of your camcorder, the current date and time will be displayed on the LCD screen for a few seconds.

## 2 Hold the camcorder properly.

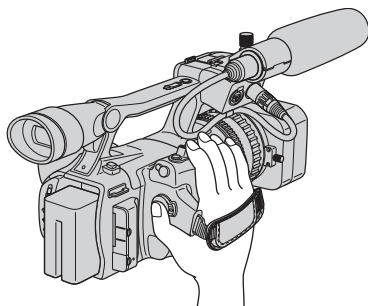

## 3 Ensure a good grip, then fasten the grip belt.

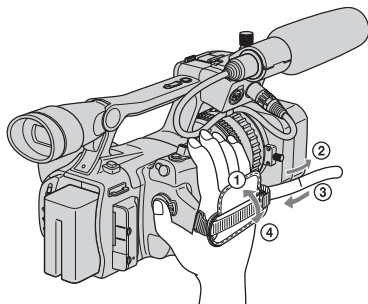

## To turn off the power

Slide the POWER switch to OFF (CHG).

### Note

- If warning messages appear on the screen, follow the instructions (p. 118).

# Step 5: Adjusting the LCD panel and viewfinder

## The LCD panel

Open the LCD panel while pressing the OPEN button 90 degrees to the camcorder (①), then rotate it to the best angle to record or play (②).

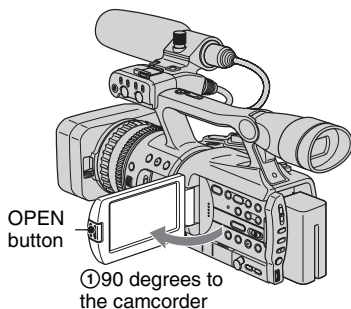

② 180 degrees (max.)

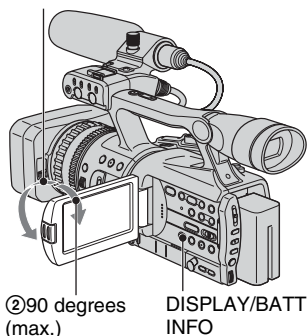

### 💡 Tips

- If you rotate the LCD panel 180 degrees toward the lens from the position ①, you can close the LCD panel with the LCD screen facing outward. This is convenient during playback operations.
- To close the LCD panel with the LCD screen inward, rotate the LCD panel to the position ①, and then close the LCD panel.

## To turn off the LCD backlight to make the battery last longer

Press and hold the DISPLAY/BATT INFO button for a few seconds until  $\square_{OFF}$  appears. This setting is practical when you use your camcorder in bright conditions or where you want to save battery power. The recorded picture will not be affected by the setting. To turn on the LCD backlight, press and hold the DISPLAY/BATT INFO button for a few seconds until  $\square_{OFF}$  disappears.

### 💡 Tip

- See [LCD BRIGHT] (p. 80) to adjust the brightness of the LCD screen.

## The viewfinder

You can view pictures using the viewfinder to save the battery, or when the picture on the LCD screen is not clear.

### Viewfinder lens adjustment lever

Move it until the picture becomes clear.

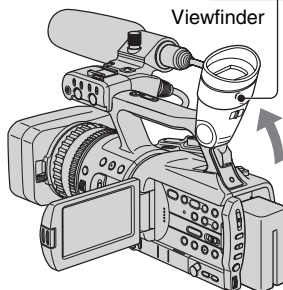

### 💡 Tips

- You can adjust the brightness of the viewfinder backlight from [VF B.LIGHT] (p. 80).
- To display images both on the LCD display and in the viewfinder, set [VF POWERMODE] to [ON](p. 80).
- To display images in black and white in the viewfinder, set [VF COLOR] to [OFF](p. 80).

## When the picture in the viewfinder is hard to see

If you cannot see the picture in the viewfinder clearly under bright circumstances, use the supplied large eyecup. To attach the large eyecup, stretch it slightly and align it with the eyecup groove in the viewfinder. You can attach the large eyecup facing either the right or left side.

### Note

- Do not remove the pre-attached eyecup.

#### Large eyecup (supplied)

Attach with the protruding part at the top.

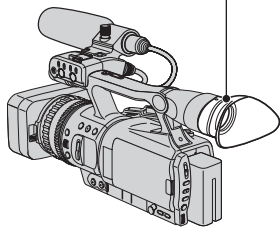
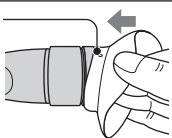

# Step 6: Setting the date and time

Set the date and time when using this camcorder for the first time. If you do not set the date and time, [CLOCK SET] screen appears every time you turn on your camcorder or change the POWER switch position.

## Tip

- If you do not use your camcorder for **about 3 months**, the built-in rechargeable battery gets discharged and the date and time settings may be cleared from the memory. In that case, charge the rechargeable battery and then set the date and time again (p. 132).

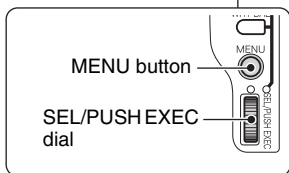
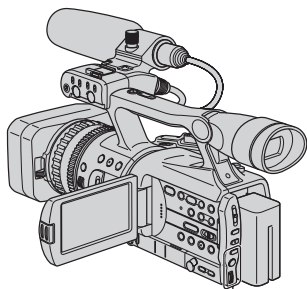

Skip to step 4 when you set the clock for the first time.

## 1 Press the MENU button.

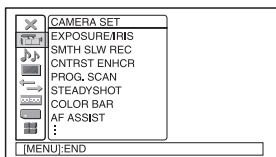

## 2 Select [OTHERS] by turning the SEL/PUSH EXEC dial, then press the dial.

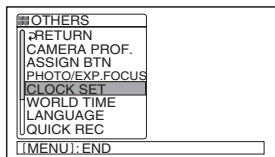

## 3 Select [CLOCK SET] by turning the SEL/PUSH EXEC dial, then press the dial.

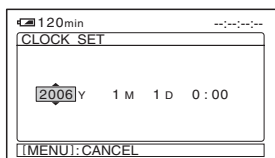

## 4 Set [Y] (year) by turning the SEL/PUSH EXEC dial, then press the dial.

You can set any year up to the year 2079.

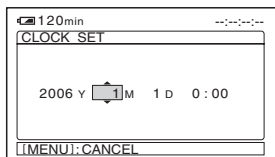

## 5 Set [M] (month), [D] (day), hour and minute, then press the dial.

The clock starts.

### Tip

- The date and time do not appear during recording, but they are automatically recorded on the tape, and can be displayed during playback ([DATA CODE] (p. 80))

### Changing the language setting

You can change the on-screen displays to show messages in a specified language.

Select the screen language in [LANGUAGE] (p. 90).

# Step 7: Inserting a tape or a “Memory Stick Duo”

## Cassette tape

See page 121 for details of usable cassettes and prevention of accidental erasure.

- 1 Slide and hold the OPEN/EJECT lever in the direction of the arrow and open the lid.

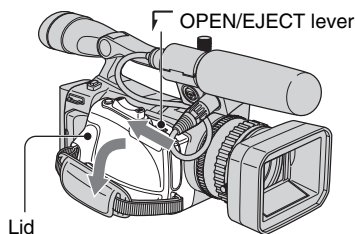

The cassette compartment automatically comes out and opens up.

- 2 Insert a cassette with its window facing outwards, then press PUSH.

Push the center of the back of the cassette lightly.

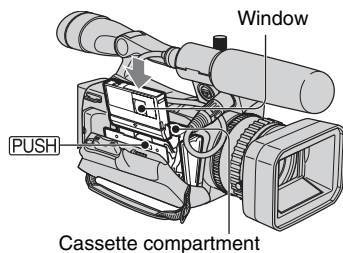

The cassette compartment automatically slides back in.

## Note

- Do not push the portion marked while it is sliding in. It may cause a malfunction.

- 3 Close the lid.

## Tip

- The recordable time varies depending on [DV REC MODE] (p. 82).

## To eject the cassette

Open the lid following the same procedure as described in step 1 and remove the cassette.

## “Memory Stick Duo”

You can use only a “Memory Stick Duo” marked with MEMORY STICK DUO or MEMORY STICK PRO DUO (p. 125).

- 1 Open the jack cover.

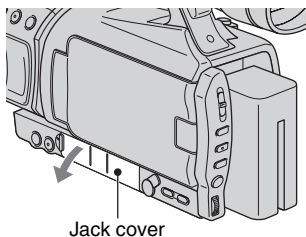

- 
- 2** Insert the “Memory Stick Duo” into the “Memory Stick Duo” slot in the right direction until it clicks.

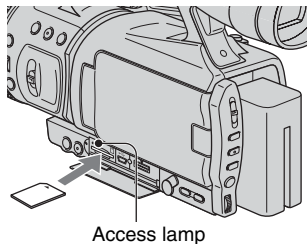

**Note**

- If you insert the “Memory Stick Duo” into the slot in the wrong direction, the “Memory Stick Duo,” the “Memory Stick Duo” slot, or image data may be damaged.

---

### To eject a “Memory Stick Duo”

Lightly push the “Memory Stick Duo” once.

**Notes**

- When the access lamp is lit or flashing, your camcorder is reading/writing data. Do not shake or knock your camcorder, turn the power off, eject the “Memory Stick Duo,” or remove the battery pack. Otherwise, image data may be damaged.
- When inserting or ejecting the “Memory Stick Duo,” be careful with the “Memory Stick Duo” from popping out and dropping.

# Recording

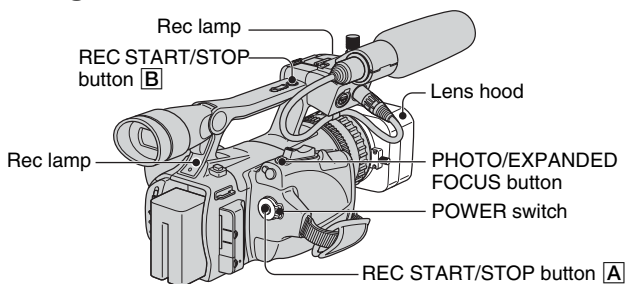

This camcorder records movies on tape and still images on “Memory Stick Duo.” The procedure for recording movies is below.

- This camcorder can record movies in HDV or DVCAM (DV) format. The factory setting is HDV format ([REC FORMAT] p. 82).

## 1 Open the shutter of the lens hood.

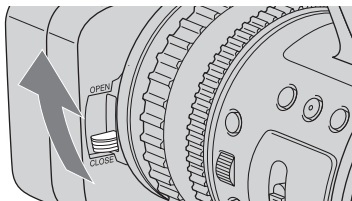

## 2 While pressing the green button, set the POWER switch to CAMERA.

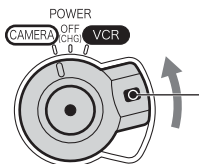

If the POWER switch is set to OFF (CHG), slide it while pressing the green button.



### 3 Press the REC START/STOP button **A** (or **B**).

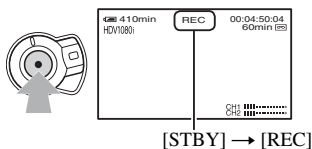

The Rec lamp lights up during recording.

To stop the movie recording, press the REC START/STOP button again.

#### Tips

- When recording in HDV format, the aspect ratio is fixed to 16:9. When recording in DVCAM (DV) format, you can switch the aspect ratio to 4:3 ([DV WIDE REC] p. 83).
- You can change the screen display during recording (p. 54).
- Indicators displayed on the screen during recording are shown on page 144.
- The recording lamp can be set to stay off ([REC LAMP] p. 91).
- You cannot record the movie on a "Memory Stick Duo".

### To record in mirror mode

Open the LCD panel 90 degrees to the camcorder (①), then rotate it 180 degrees toward the lens (②).

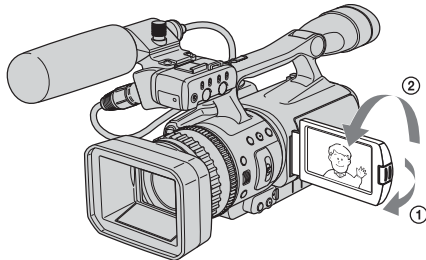

#### Tip

- A mirror-image of the subject appears on the LCD screen, but the recorded picture will be normal.

### To record still images

Press the PHOTO/EXPANDED FOCUS button. The image is recorded on a “Memory Stick Duo.” Recording is complete when  disappears. You can also record still images during movie recording.

#### Tips

- When you are not recording a movie, you will hear the shutter click.
- The still image size is as follows:
  - When recording in HDV or DVCAM (DV) (16:9) format: 1.2M (1,440 × 810 dots)
  - When recording in DVCAM (DV) (4:3) format: 0.9M (1,080 × 810 dots)
- You can change the image quality and number of recordable images (QUALITY] (p. 87)).
- Indicators displayed on the screen during shooting are shown on page 144.
- You can set the PHOTO/EXPANDED FOCUS button to start the expanded focus function as you press the button ([PHOTO/EXP.FOCUS] (p. 90)).

# Playback

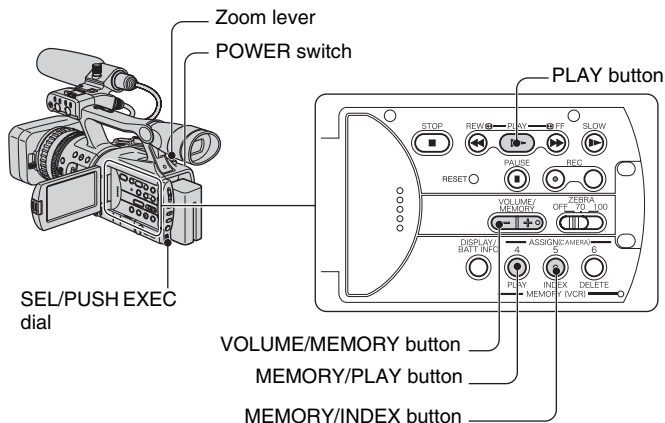

You can play back movies as follows.

- 1** While pressing the green button, set the POWER switch to VCR.

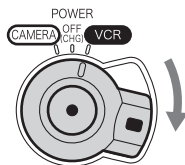

- 2** Start playing back.

Press ◀◀ (rewind) to go to the point you want to view, then press ▶▶ (play) to start playback.

- ■ : Stop
- || : Pause (Press ▶▶ or || again to restart the playback)
- ▶▶ ◀◀ : Forward/Rewind
- ▶▶ : Slow

### ⓘ Notes

- Playback automatically stops if pause is engaged for more than 3 minutes.
- When playing back a tape recorded in the HDV and DVCAM (DV) formats and the signal switches between HDV and DVCAM (DV), the picture and sound disappear temporarily.
- You cannot play back the tape recorded in the HDV format on video cameras of the DVCAM (DV) format or mini-DV players.
- DV format tapes are played back on your camcorder only if they are recorded in the SP mode (SP appears on the screen). Tapes recorded in the LP mode are not played back.

## Playback (Continued)

- Time code and user bits are not displayed correctly unless time code and user bits are recorded on the tape, or the recorded time code is compatible with your camcorder.

### Tips

- Indicators displayed on the screen during playback are shown on page 145.
- You can change the screen display during playback (p. 54).

---

### To search for a scene while viewing a movie

Press **▶▶/◀◀** during playback (Picture Search). To view during fast forward press and hold **▶▶** and to view during rewind press and hold **◀◀** (Skip Scan).

### Note

- Reverse picture search/skip scan is not possible with tapes recorded in HDV format.

### To adjust the volume

Adjust using the VOLUME/MEMORY button.

### To view still images

- ① Slide the POWER switch to VCR.
- ② Press the MEMORY/PLAY button.
- ③ Select still image that you want to look using the VOLUME/MEMORY button.  
To stop viewing still images, press the MEMORY/PLAY button once more.

### To display the list of still images (index screen)

- ① Slide the POWER switch to VCR.
- ② Press the MEMORY/INDEX button.

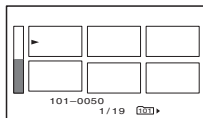

- ③ Select a picture by pressing the VOLUME/MEMORY button.  
To display a single image, move **▶** to that image and press the MEMORY/PLAY button.  
To stop displaying the list of still photos, press the MEMORY/INDEX button again.

# Changing the settings of your camcorder recordings

## Adjusting the zoom

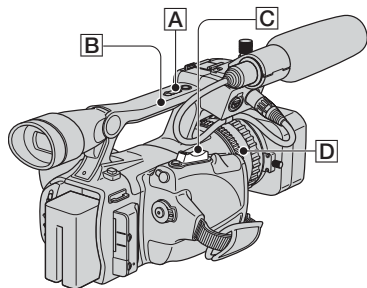

Move the power zoom lever **C** slightly for a slower zoom. Move it further for a faster zoom.

**Wide view:** (Wide angle)

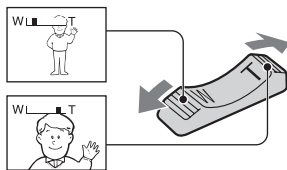

**Close view:** (Telephoto)

### 💡 Tips

- The minimum distance required between your camcorder and the subject for focus is about 1 cm (about 13/32 in.) for wide angle and about 80 cm (about 2 5/8 feet) for telephoto.
- The focus may not be adjusted at certain zoom positions if the subject is within 80 cm (about 2 5/8 feet) from your camcorder.
- When [FOCUS MACRO] is set to [OFF], you cannot focus on a subject within 80cm (about 2 5/8 feet) regardless of the zoom position (p. 71).
- Be sure to keep your finger on the power zoom lever. If you move your finger off the power zoom lever, the operation sound of the power zoom lever may also be recorded.

## Using the handle zoom

- ① Set the handle zoom switch **B** to H (high) or L (low).

### 💡 Tip

- You can set the zoom speed of the handle zoom lever in [HANDLE ZOOM] (p. 72).

- ② Press the handle zoom lever **A** to zoom in or out.

### ⚠ Notes

- You cannot adjust the zoom speed by pressing the handle zoom lever.
- You cannot use the handle zoom lever when the handle zoom switch **B** is set to OFF.
- You cannot change the zoom speed of the zoom lever **C** with the handle zoom switch **B**.

## Using the zoom ring

You can zoom at the desired speed by turning the zoom ring **D**. Fine adjustment is also possible.

### ⚠ Note

- Turn the zoom ring **D** at a reasonable speed. If you turn it too fast, the zoom speed may not catch up with the zoom ring rotating speed.

### Adjusting the focus manually

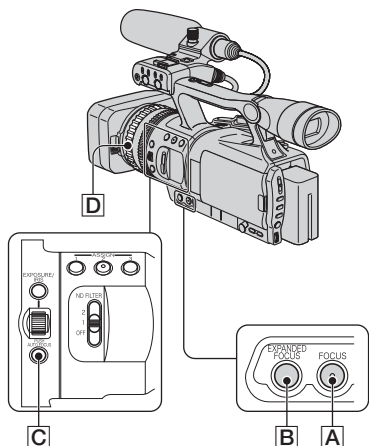

You can adjust the focus manually for different recording conditions. Use this function in the following cases.

- To record a subject behind a window covered with raindrops.
- To record horizontal stripes.
- To record a subject with little contrast between the subject and its background.
- When you want to focus on a subject in the background.

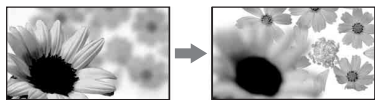





- To record a stationary subject using a tripod.

### 1 During recording or standby, press the FOCUS button [A].

 appears.

### 2 Rotate the focus ring [D] and adjust the focus.

 changes to  when the focus cannot be adjusted any farther.  changes to  when the focus cannot be adjusted any closer.

### Tips

For focusing manually

- It is easier to focus on the subject when you use the zoom function. Move the power zoom lever towards T (telephoto) to adjust the focus, and then, towards W (wide angle) to adjust the zoom for recording.
- When you want to record a close-up image of a subject, move the power zoom lever towards W (wide angle) to fully magnify the image, then adjust the focus.

### To restore automatic adjustment

Press the FOCUS button [A] once again.  disappears and AUTO FOCUS is restored.

### To use AUTO FOCUS temporarily (One push auto focus)

Record the subject while pressing and holding the PUSH AUTO FOCUS button [C].

If you release the button, the setting returns to manual focusing.

Use this function to shift the focus on one subject to another. The scenes will shift smoothly.

## 💡 Tip

- The focal distance information (for when it is dark and hard to adjust the focus) appears for about 3 seconds in the following cases. (It will not be displayed correctly if you are using a conversion lens (optional)).
  - When the focus mode is switched from automatic to manual.
  - When you rotate the focus ring.

### To use the expanded focus (Expanded focus)

During standby, press the EXPANDED FOCUS button **[B]**. [EXPANDED FOCUS] appears and the center of the screen is magnified by about 2.0 times (about 1.5 times during [PROG. SCAN]). It will be easier to confirm the focus setting during manual focusing. The screen returns to the original size when you push the button again.

## 🔊 Note

- The image returns to the original size when you press the REC START/STOP button or the PHOTO/EXPANDED FOCUS button.

## 💡 Tips

- You can select the type of a picture on EXPANDED FOCUS ([EXP.FOCUS TYPE] p. 78).
- Unless [REC CTL MODE] is set to [OFF], the following functions are disabled.
  - EXPANDED FOCUS button
  - ASSIGN button to which [ALLSCAN MODE] is assigned.

## Adjusting the EXPOSURE/IRIS

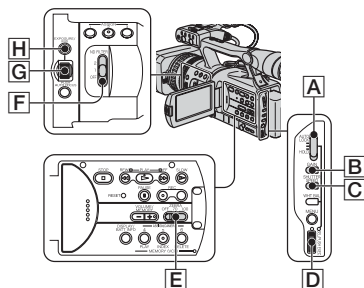

You can adjust the brightness of a picture with the EXPOSURE/IRIS dial **[G]**. You can assign any one of [EXPOSURE1] (the default setting), [EXPOSURE2], [IRIS] and [AE SHIFT] to the EXPOSURE/IRIS dial **[G]** from the menu (p. 69).

## 💡 Tips

- Even if you open the aperture more than F2.8 (i.e. make the iris value smaller, such as F1.6) during EXPOSURE/IRIS setting, changing the zoom from wide to telephoto will change the iris to F2.8.
- When the EXPOSURE/IRIS dial is set to [EXPOSURE1] or [EXPOSURE2], **[E]** appears next to the values that can be set with the dial.

### ■ EXPOSURE1 (the default setting)

You can adjust the display brightness by adjusting the iris and gain (the shutter speed remains fixed).

The iris, gain and shutter speed are displayed on the screen.

Select this function if you want to adjust the brightness in a wide range.



## 🔊 Note

- The GAIN button and the SHUTTER SPEED button are inactive.

## Changing the settings of your camcorder recordings (Continued)

### Tip

- This is handy for changing the brightness of the screen and setting the desired brightness by dial operation.

### ■ EXPOSURE2

You can adjust the display brightness by adjusting the iris (the gain and shutter speed remain fixed).

The iris, gain and shutter speed are displayed on the screen.

Select this function if you do not want fuzzy display caused by high-gain.



### Note

- The GAIN button and the SHUTTER SPEED button are inactive.

### Tip

- This is handy for changing the brightness of the screen and setting the desired brightness by dial operation.

### ■ IRIS

You can manually adjust the light volume of the light entering the lens between F1.6 and F11 or close the aperture.

As the iris is opened (smaller aperture values), the light volume increases or the iris is closed (larger aperture values), the light volume decreases. The current aperture value (F) appears on the screen.



### Tips

- The range of focus, an important effect of the aperture, is called the depth of field. The depth of field gets shallower as the aperture is opened, and deeper as the aperture is closed. Use the aperture creatively to obtain the desired effect in your photography.
- This is handy for making the background blurred or sharp, or when you want to manually adjust the iris, gain or shutter speed on the screen.

### ■ AE SHIFT

You can slightly adjust the exposure between -7 (dark) and +7 (bright) during the auto recording. **AS** appears.



### Notes

- [AE SHIFT] does not work when the exposure is manually set or the iris, gain and shutter speed are all set manually.
- This function is not effective when [HYPER GAIN] is set.

### Tip

- You can adjust the AE SHIFT from the menu (p. 71).

---

## 1 During recording or standby, set the AUTO LOCK switch **A** to the center position to release the auto lock mode.

This operation is not required when AE SHIFT is assigned to the EXPOSURE/IRIS dial.

---

## 2 Press the EXPOSURE/IRIS button **H**.

The EXPOSURE/IRIS dial **G** will be effective.



### 3 Adjust the picture quality by turning the EXPOSURE/IRIS dial

**G**.

#### 💡 Tip

- If you set the AUTO LOCK switch **A** to HOLD after manual adjustment, the manually adjusted items are saved.

### To restore automatic adjustment

Press the EXPOSURE/IRIS button **H**, or set the AUTO LOCK switch **A** to AUTO LOCK.

#### 🔊 Notes

- If you set the AUTO LOCK switch **A** to AUTO LOCK, other manually adjusted items (gain, shutter speed, white balance) also become temporarily automatic.
- As you shift the zoom from W (wide) to T (telephoto), the aperture value varies from F1.6 to F2.8.

#### 💡 Tips

- You can adjust the dial sensitivity of the EXPOSURE/IRIS dial **G** by selecting [EXPOSURE/IRIS] → [DIAL SENS](p. 69), and the dial operating direction by selecting [EXPOSURE/IRIS] → [DIAL ROTATE] (p. 69).
- Settings can also be checked by pressing the STATUS CHECK button (p. 54).
- See page 74 for [BACK LIGHT].

### Adjusting the volume of light (ND filter)

You can record the subject clearly by using the ND filter when the recording environment is too bright.

There are 2 levels of ND filter setting. ND filter 1 reduces the volume of light to about 1/4, and ND filter 2 to about 1/16.

If **ND<sub>1</sub>** flashes during standby mode, set the ND FILTER switch **F** to 1 to turn on the **ND<sub>1</sub>** indicator. If **ND<sub>2</sub>** flashes, set the ND FILTER switch to 2 to turn on the **ND<sub>2</sub>** indicator. If **ND<sub>OFF</sub>** flashes, set the ND FILTER switch to OFF to turn off the indicator.

#### 🔊 Notes

- If you move the ND FILTER switch during recording, the picture and sound may be distorted.
- If you adjust the iris manually, no ND filter indicator will appear even if the ND filter should be activated.

#### 💡 Tip

- If you close the iris extensively when recording a bright subject, diffraction may occur, resulting in a fuzzy focus (this is a common phenomenon with video cameras). The ND filter suppresses this phenomenon and gives better recording results.

### Displaying the zebra pattern to adjust the brightness

If there is a part of the screen where brightness is over a certain level, the part may appear excessively white when played back. By displaying the zebra pattern on such a part, you can be reminded to adjust the brightness before recording.

Select the brightness level to display the zebra pattern with the ZEBRA switch **E**, then the zebra pattern will appear.

Select the brilliance value from 70 or 100.

If you select 70, the zebra pattern appears at the part with 70±5 % of the brilliance signal. If you select 100, the zebra pattern appears at the part with 100 % or more.

## Changing the settings of your camcorder recordings (Continued)

### To hide the zebra pattern

- Set the ZEBRA switch [E] to OFF.

#### Note

- The zebra pattern is not recorded on the tape.

#### Tip

- This is convenient for adjusting the brightness while a histogram (p. 78) is displayed.

### Adjusting the gain

You can adjust the gain manually when shooting blackish or dark objects if you do not want the AGC (auto gain control) to be activated.

- ① During recording or standby, set the AUTO LOCK switch [A] to the center position to release the auto lock.
- ② Press the GAIN button [B].  
The current gain value appears.
- ③ Adjust the gain by turning the SEL/PUSH EXEC dial [D].  
The gain can be adjusted between 0dB and 18dB by every 3dB.

#### Tip

- The gain value can be stored temporarily by setting the AUTO LOCK switch [A] to HOLD after the manual adjustment.

### To restore automatic adjustment

Press the GAIN button [B], or set the AUTO LOCK switch [A] to AUTO LOCK.

#### Note

- If you set the AUTO LOCK switch [A] to AUTO LOCK, other manually adjusted items (iris, shutter speed, white balance) also become temporarily automatic.

### Adjusting the shutter speed

You can manually adjust and fix the shutter speed. Depending on the shutter speed, you can make the subject look still, or emphasize the fluidity of movement.

- ① During recording or standby, set the AUTO LOCK switch [A] to the center position to release the auto lock mode.
- ② Press the SHUTTER SPEED button [C].
- ③ Adjust the shutter speed by turning the SEL/PUSH EXEC dial [D].  
You can set a shutter speed between 1/3 second and 1/10000 second.  
The selected shutter speed appears on the screen. For example, if you select 1/100 second, [100] appears. The larger the number that appears on the screen, the faster the shutter speed.

#### Tip

- The shutter speed can be stored temporarily by setting the AUTO LOCK switch [A] to HOLD after the manual adjustment.

### To restore automatic adjustment

Press the SHUTTER SPEED button [C], or set the AUTO LOCK switch [A] to AUTO LOCK.

#### Note

- If you set the AUTO LOCK switch [A] to AUTO LOCK, other manually adjusted items (iris, gain, white balance) also become temporarily automatic.

#### Tips

- It is difficult to focus automatically at a lower shutter speed. Manual focusing with your camcorder attached to a tripod is recommended.
- The picture may flicker or change colors under fluorescent lamps, sodium lamps, or mercury lamps.

## Adjusting to Natural Color (White balance)

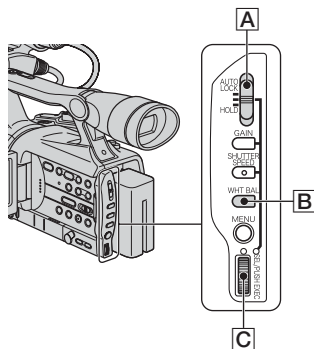

You can adjust the white balance according to the light of the recording environment. You can set two sets of white balance adjustment data separately in memory A and memory B for two different recording conditions with A and B. During recording, you can select the setup data with the SEL/PUSH EXEC dial. The setup data will be retained as long as it is not readjusted even if the power is disconnected.

**1** During recording or standby, set the AUTO LOCK switch A to the center position to release the auto lock mode.

**2** Press the WHT BAL button B.

**3** Display desired item by turning the SEL/PUSH EXEC dial C, then press the dial.

The display changes. A → B  
→ (Outdoor) → (Indoor)

Indicator	Shooting conditions
A (MEMORY A)	<ul style="list-style-type: none"> <li>White balance values adjusted for light sources can be stored in memory A and memory B. Follow the steps below</li> </ul>
B (MEMORY B)	
(Outdoor)	<ul style="list-style-type: none"> <li>Recording a sunset/sunrise, just after sunset, just before sunrise, neon signs, or fireworks.</li> <li>Under daylight color fluorescent lamps</li> </ul>
(Indoor)	<ul style="list-style-type: none"> <li>Under the lighting condition that changes quickly</li> <li>Under strong light such as in a photography studio</li> <li>Under sodium lamps or mercury lamps</li> </ul>

### Tip

- You can change the white balance value for (Outdoor) by pressing and turning the SEL/PUSH EXEC dial when (Outdoor) is selected. The value can be set between -7 (bluish) and +7 (reddish). The default value is 0.

### To save the adjusted white balance value in memory A or B

- Select A or B according to step 3 of “Adjusting to Natural Color (White Balance).”
- Shoot something white (such as a sheet of paper) full-screen under the same lighting conditions as the subject.
- Press the SEL/PUSH EXEC dial C. Pressing the dial switches between blinking A and B.

When the white balance is adjusted, A or B stops blinking and remains on. The adjusted value is now saved in the selected A or B memory.

## Changing the settings of your camcorder recordings (Continued)

### To restore the automatic white balance

Press the WHT BAL button **[B]**, or set the AUTO LOCK switch **[A]** to AUTO LOCK.

#### **Note**

- If you set the AUTO LOCK switch **[A]** to AUTO LOCK, other manually adjusted items (iris, gain, shutter speed) also become temporarily automatic.

### Customizing the picture quality (Picture profile)

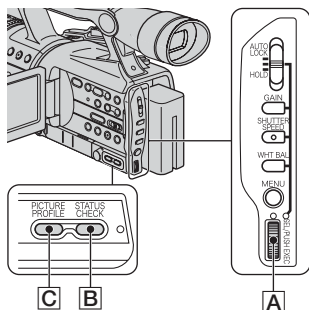

You can customize the picture quality by adjusting [COLOR LEVEL], [SHARPNESS], etc. You can set 6 different picture quality settings depending on the recording time of day, the weather, or the camera person, and store them in the memory.

Connect your camcorder to a TV or monitor, and adjust the picture quality while observing the picture on the TV or monitor screen.

At the default setting, [PP1] through [PP6] are registered with picture quality settings for the following recording conditions.

Picture profile number (setting name)	Recording condition
PP1 :PORTRAIT	Appropriate setting to record people
PP2 :CINEMA	Appropriate setting to record film-like pictures
PP3 :SUNSET	Appropriate setting to record sunset
PP4 :MONOTONE	Appropriate setting to record monotone pictures
PP5 :-----	You can assign your own setting

Picture profile number (setting name)	Recording condition
PP6 :-----	You can assign your own setting.

**1** During standby, press the PICTURE PROFILE button **[C]**.

**2** Select a picture profile number by turning the SEL/PUSH EXEC dial **[A]**, then press the dial.

You can shoot with the settings of the selected picture profile.

**3** Select [OK] by turning the SEL/PUSH EXEC dial **[A]**.

### To cancel the picture profile recording

Select [OFF] in step 2, then press the SEL/PUSH EXEC dial **[A]**.

### To change the picture profile

You can change the settings in [PP1] through [PP6].

- Press the PICTURE PROFILE button **[C]**.
- Select the PICTURE PROFILE number by turning the SEL/PUSH EXEC dial **[A]**, then press the dial.
- Select [SETTING] by turning the SEL/PUSH EXEC dial **[A]**, then press the dial.
- Select an item to be adjusted by turning the SEL/PUSH EXEC dial **[A]**, then press the dial.
- Adjust the picture quality by turning the SEL/PUSH EXEC dial **[A]**, then press the dial.

Item	Adjustment
[COLOR LEVEL]	-7 (low) to +7 (high) -8 (black and white)
[COLOR PHASE]	-7 (greenish) to +7 (reddish)
[SHARPNESS]	0 (softer) to 15 (clearer)
[SKINTONE DTL]	To make wrinkles less noticeable by suppressing the outlines on the part of skin color. [TYPE1] (the color range recognized as a skin color is narrow) to [TYPE3] (the color range recognized as a skin color is wide) [OFF] no adjustment
[SKINTONE LVL]	To set the level of outline suppression performed by setting [SKINTONE DTL]. 1 (low suppression) - 6 (high suppression)
[WB SHIFT]	-7 (to make picture bluish) to +7 (to make white parts reddish)

## Changing the settings of your camcorder recordings (Continued)

Item	Adjustment
[KNEE POINT]	The starting point of video signal compression, set in order to prevent overexposed highlights by keeping the subject's high-brightness area signal within the dynamic range of your camcorder. [AUTO] To automatically set the knee point. [HIGH] To set a relatively high knee point. [MIDDLE] To set an average knee point. [LOW] To set a relatively low knee point.
[BLK COMPNST N]	[OFF] Normal setting [STRETCH] To improve $\gamma$ -curve characteristics in dark areas to enhance gradation in those areas. [COMPRESS] To controls $\gamma$ -curve characteristics to produce solid black.

Item	Adjustment
[CINEMA-TONE GAMMA]	[OFF] Normal recording [TYPE1] A better tone scale than the standard video gamma reproduces natural intermediate colors between a skin color and neutral colors. A skin color will look lively when recorded with this setting. Further, the reproduction of extremely precise description of highlighted parts provides depth in pictures. [TYPE2] In addition to the features of [TYPE1], this setting is capable of extremely precise description of the entire exposure zone from shadowed parts to highlighted parts, which enables reproduction of a deeper black.
[CINEMA-TONE COLOR]	[OFF] Normal setting [ON] Colors similar to film camera images. This is effective when used with [CINEMATONE GAMMA] This is also effective for black and white recording with [COLOR LEVEL] set to [-8]. In this case, the brightness level of a color image will vary.
[PROFILE NAME]	To name the set picture profiles [PP1] through [PP6] (p. 44)
[COPY]	To copy a picture profile setting to other picture profiles
[RESET]	To restore the default setting of the picture profile

- ⑥ Repeat steps 4 and 5 to adjust other items.
- ⑦ Select [↵ RETURN] by turning the SEL/PUSH EXEC dial [A], then press the dial.
- ⑧ Select [OK] by turning the SEL/PUSH EXEC dial [A], then press the dial.  
A picture profile indicator appears.

#### ⚡ Note

- In the case of [TYPE3] of [SKINTONE DTL], the effect may also be applied to a color that is not a skin color.

### To check the picture profile settings

During recording or during standby, press the STATUS CHECK button [B] (p. 54).

#### ⚡ Tip

- You can assign picture profiles to the ASSIGN buttons and use them to turn the picture profiles on and off (p. 49).

### To name the picture profile settings

You can name on picture profile 1~6.

- ① Press the PICTURE PROFILE button [C].
- ② Select the picture profile that you want to name by turning the SEL/PUSH EXEC dial [A], then press the dial.
- ③ Select [SETTING] → [PROFILE NAME] by the SEL/PUSH EXEC dial [A].
- ④ Select a letter by turning the SEL/PUSH EXEC dial [A], then press the dial.  
Repeat this operation until a complete name is entered.

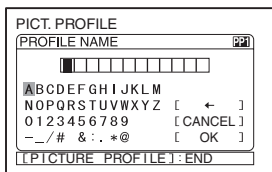

#### ⚡ Tip

- Each name can be up to 12 characters long.  
Characters that can be used in profile names:
  - A~Z
  - 0~9
  - -\_ / # & : . \* @
- ⑤ Select [OK] by turning the SEL/PUSH EXEC dial [A], then press the dial. The profile name is changed.
- ⑥ Select [↵ RETURN] → [OK] by the SEL/PUSH EXEC dial [A].

### To copy the picture profile setting to other picture profiles

- ① Press the PICTURE PROFILE button [C].
- ② Select the picture profile that you want to copy from by turning the SEL/PUSH EXEC dial [A], then press the dial.
- ③ Select [SETTING] → [COPY] by SEL/PUSH EXEC dial [A].
- ④ Select the number of the picture profile that you want to copy to by turning the SEL/PUSH EXEC dial [A], then press the dial.
- ⑤ Select [YES] by turning the SEL/PUSH EXEC dial [A], then press the dial.
- ⑥ Select [↵ RETURN] → [OK] by the SEL/PUSH EXEC dial [A].

### To reset the picture profile settings

You can reset the picture profile settings by each picture profile number. You cannot reset all picture profile settings at once.

- ① Press the PICTURE PROFILE button [C].
- ② Select the picture profile by turning the SEL/PUSH EXEC dial [A], then press the dial.
- ③ Select [SETTING] → [RESET] → [YES] → [↵ RETURN] → [OK] by the SEL/PUSH EXEC dial [A].

## Changing the settings of your camcorder recordings (Continued)

### Adjusting the volume

You can adjust the volume of a microphone connected to INPUT1/INPUT2.

#### 💡 Tip

- You can find how to attach the supplied microphone on page 20.

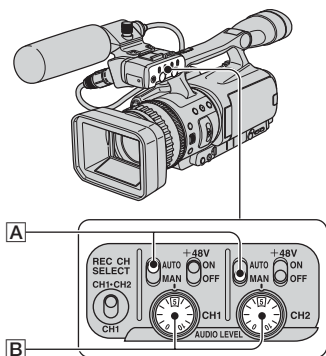

- 1** Set the AUTO/MAN switch **A** of the channel to be adjusted to **MAN**.

♪<sub>M</sub> appears on the screen.

- 2** Turn the **AUDIO LEVEL** dial **B** to adjust the volume.

You can adjust the volume of the microphone connected to INPUT1 by CH1, and that of the microphone connected to INPUT2 by CH2.

### To restore automatic adjustment

Set the AUTO/MAN switch **A** of the manually adjusted channel to AUTO.

#### 📌 Note

- If you are connecting a device other than a 48-V microphone, set the +48V switch to OFF. If you

use the device while the +48V switch is set to ON, the device may be damaged.



# Assigning the functions to the ASSIGN buttons

You may need to assign some functions to the ASSIGN buttons. You can assign a single function to each the ASSIGN button 1 to 6.

## Functions you can assign to the ASSIGN buttons

- LAST SCN RVW (p. 51)
- MARKER (p. 78)
- HYPER GAIN (p. 74)
- D.EXTENDER (p. 74)
- ALLSCAN MODE (p. 79)
- FOCUS INFNTY (p. 50)
- REC REVIEW (p. 51)
- END SEARCH (p. 51)
- INDEX MARK (p. 50)
- PEAKING (p. 77)
- STEADYSHOT (p. 70)
- COLOR BAR (p. 70)
- FOCUS MACRO (p. 71)
- SPOTLIGHT (p. 74)
- BACK LIGHT (p. 74)
- FADER (p. 75)
- DISPLAY (p. 54)
- Picture profile (p. 44)
- SHOT TRANS (p. 52)

### Note

- The ASSIGN buttons 4 to 6 are exclusively used for memory playback when the POWER switch is set to VCR, and cannot be used as ASSIGN buttons. You cannot assign functions to the ASSIGN buttons 4 to 6 while the POWER switch is set to VCR.

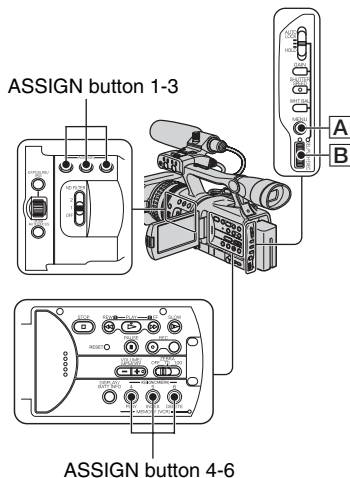

**1** Press the MENU button **A**.

**2** Select the  (OTHERS) → [ASSIGN BTN] by the SEL/PUSH EXEC dial **B**.

**3** Select the number of the ASSIGN button (ASSIGN 1-6, [SHOT TRANS]) you want to assign the function by turning the SEL/PUSH EXEC dial **B**, then press the dial.

- [-----] is displayed at the number that no function is assigned.
- When you select [SHOT TRANS], select [YES], then proceed to step 6.

**4** Select the function to be assigned by turning the SEL/PUSH EXEC dial **B**, then press the dial.

## Assigning the functions to the ASSIGN buttons (Continued)

---

**5** Select [OK] by turning the SEL/PUSH EXEC dial , then press the dial.

---

**6** Press the MENU button  to hide the menu.

### Tips

- Shot transition is assigned to the ASSIGN buttons 1, 2 and 3 (p. 52). Cancel the shot transition assignment to return to the pre-setting assignment.
- To cancel the shot transition, select [SHOT TRANS] → [YES] in step 3.

### Focusing on a distant subject (Focus infinity)

#### Note

- [FOCUS INFNTY] is only available during the manual focus. It is not available during the auto focus.

---

**1** Assign [FOCUS INFNTY] to one of the ASSIGN buttons (p. 49).

---

**2** Press the ASSIGN button assigned to [FOCUS INFNTY].

 appears.

If you release the switch, it returns to manual focusing.

Use this function to record a distant subject when the focus is automatically set on a close subject.

### Recording an index signal

If you make an index for a scene, you can easily search for the scene later (p. 56).

The index function will make it easier to check the transition of recording or edit your pictures using index signals.

---

**1** Assign [INDEX MARK] to one of the ASSIGN buttons in advance (p. 49).

---

**2** Press the ASSIGN button assigned to [INDEX MARK].

#### When pressed during recording

 appears for about 7 seconds and an index signal is recorded.

#### When pressed during standby

 flashes.

After you press the REC START/STOP button to start recording,  appears for about 7 seconds and an index signal is recorded.

---

### To cancel the operation

Before starting to record, press the ASSIGN button assigned to [INDEX MARK] again.

#### Note

- You cannot record an index signal on a recorded tape afterward.

## Reviewing the most recently recorded scenes (Rec review)

You can view about 2 seconds of the scene recorded just before you stopped the tape. This is convenient during playback of the latest scene check.

---

**1** Assign [REC REVIEW] to one of the ASSIGN buttons in advance. (p. 49).

---

**2** Press the ASSIGN button assigned to [REC REVIEW] during standby mode.

The last 2 seconds (approx.) of the most recently recorded scene are played back. Then, your camcorder is set to standby.

## Searching for the last scene of the most recent recording (End search)

### Note

- End search will not work correctly when there is a blank section between recorded sections on the tape.

---

**1** Assign [END SEARCH] to one of the ASSIGN buttons in advance (p. 49).

---

**2** Press the ASSIGN button to which [END SEARCH] is assigned.

The last scene of the most recent recording played back for about 5 seconds, and the camcorder enters the standby mode at the point where the last recording has finished.

---

### Note

- The End search function will not work correctly when there is a blank section between recorded sections on the tape.

## Playing back the most recently recorded movies (Last scene review)

You can let your camcorder to automatically rewind the tape to the beginning of the most recently recorded scene, play back to the end of the scene, then stop the playback.

---

**1** Assign [LAST SCN RVW] to an ASSIGN button (p. 49).

---

**2** During standby, press the ASSIGN button to which [LAST SCN RVW] is assigned.

[LAST SCN RVW] will be executed.

---

### Note

- If the recording time of the movie is short, [LAST SCN RVW] may not be executed correctly.

## Assigning the functions to the ASSIGN buttons (Continued)

### Tip

- If you press the ASSIGN button again during the last scene review, your camcorder plays back the last 5 seconds of the most recently recorded movie, then goes to standby at the end of the recording.

## Using the Shot transition

You can register the settings of focus, zoom, iris, gain, shutter speed, and white balance, and then change the recording setting from the current one to the registered one, resulting in a smooth transition of scenes (Shot transition). For example, you can shift the focus from closer objects to farther objects, or change the depth of field by adjusting the iris. In addition, you can develop scenes under different recording conditions smoothly. If you register the manual adjustment function of the white balance, the scenes will develop smoothly between objects indoor and those outdoor.

Use a tripod to avoid camera-shake.



You can set the transition curve and duration etc. using [SHOT TRANS] (p. 72).

ASSIGN button 1-3

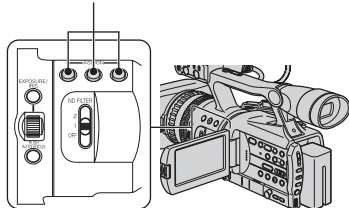

## 1 Assign [SHOT TRANS] to one of the ASSIGN buttons (p. 49).

### Tip

- Shot transition is assigned to ASSIGN buttons 1, 2 and 3.

## 2 Store the settings (shot).

- ① Press the ASSIGN button 1 repeatedly to bring up the SHOT TRANSITION STORE screen.

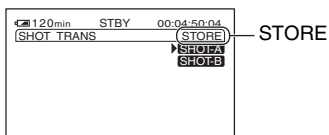

- ② Adjust the desired items manually. See pages 37 to 43 for details on adjustment.
- ③ Press the ASSIGN button 2 for storing the setting in SHOT-A, or the ASSIGN button 3 for storing the setting in SHOT-B.

### Note

- The setting values assigned to SHOT-A and SHOT-B are deleted when the POWER switch is set to OFF (CHG).

## 3 Check the stored settings.

- ① Press the ASSIGN button 1 repeatedly to bring up the SHOT TRANSITION CHECK screen.

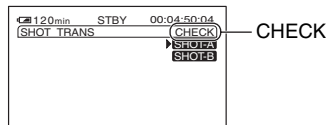

- ② Press the ASSIGN button 2 to check the SHOT-A. Press the ASSIGN button 3 to check the SHOT-B.

The selected setting will take effect on the picture on the screen. The focus, zoom, and so on, are automatically adjusted as stored in the setting.

#### Note

- You cannot check the transition time and curve set using [SHOT TRANS] (p. 72).

## 4 Record using the shot transition function.

- ① Press the ASSIGN button 1 repeatedly to bring up the SHOT TRANSITION EXEC screen.

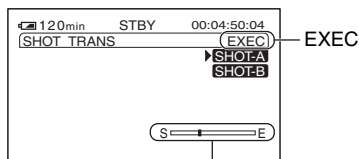

Transition bar  
S: start  
E: end

- ② Press the REC START/STOP button.  
③ Press the ASSIGN button 2 to record movie using the SHOT-A. Press the ASSIGN button 3 to record movie using the SHOT-B.  
Pictures will be recorded with the settings that are changed automatically from the current ones to the stored ones.

#### Tip

- Press the ASSIGN button 1 repeatedly to cancel the SHOT TRANSITION.

#### Notes

- You cannot zoom, focus, or adjust manually while checking or activating the Shot transition.
- When you change [SHOT TRANS] (p. 72), press the ASSIGN button 1 repeatedly to exit the shot transition screen.
- You cannot return from the stored SHOT-A or SHOT-B settings to previous settings after you activate the shot transition during recording.
- If you press the following buttons during the shot transition operation, the operation is canceled:
  - PICTURE PROFILE
  - MENU
  - EXPANDED FOCUS
  - STATUS CHECK

#### Tips

- You can also make a transition from saved SHOT-A to saved SHOT-B or vice versa. For example, to make a transition from SHOT-A to SHOT-B. Display the shot transition CHECK screen, press the ASSIGN button 2 and press the REC START/STOP button. Next, display the shot transition EXEC screen and press the ASSIGN button 3.
- You can rehearse the shot transition by pressing the ASSIGN button 2 or 3, in which the desired setting was stored, before pressing the REC START/STOP button in step 4.

#### To cancel the operation

Press the ASSIGN button 1 repeatedly to exit the shot transition screen.

# Changing/checking the settings in your camcorder

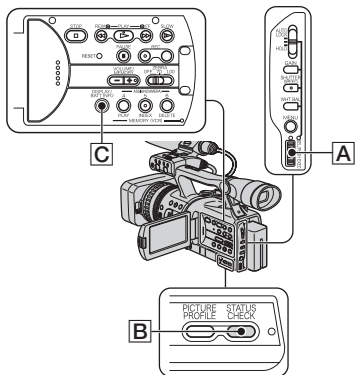

## Changing the screen

You can turn on and off the display of the time code, tape counter, and other information on the screen.

### Press the DISPLAY/BATT INFO button **C**.

The screen indicators turn on (displayed) and off (undisplayed) as you press the button.

When the POWER switch is set to CAMERA, the screen changes (detailed display → simple display → no display) as you press the button.

#### Tip

- You can display the screen indicators during playback on a TV. Select [DISP OUTPUT], then [V-OUT/PANEL] (p. 81).

## Displaying the settings in your camcorder (Status check)

You can check the setup value of the following items.

- Audio setup such as [DV AUDIO MIX] (p. 77)
- Output signal setup ([VCR HDV/DV], etc.) (p. 82)
- Functions assigned to the ASSIGN buttons (p. 49)
- Camera setup. (p. 69)
- Picture profile (p. 44)

### 1 Press the STATUS CHECK button **B**.

### 2 Turn the SEL/PUSH EXEC dial **A** to display the desired item.

When the POWER switch is set to CAMERA, the items appear in the following order:

AUDIO → OUTPUT → ASSIGN → CAMERA → PICT.PROFILE

When the POWER switch is set to VCR, the items appear in the following order:

AUDIO → OUTPUT → ASSIGN

#### Note

- When [PICT.PROFILE] is set to [OFF], the settings of PICTURE PROFILE are not displayed.

### To turn off the setup value

- Press the STATUS CHECK button **B**.

## Checking the remaining battery (Battery Info)

Set the POWER switch to OFF (CHG), then press the DISPLAY/BATT INFO button . The approximate recordable time in the selected format and battery information appear for about 7 seconds. You can view the battery information for up to 20 seconds by pressing the button again while the information is displayed.

Remaining battery (approx.)

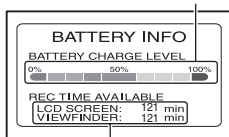

Recording capacity (approx.)

# Locating a scene on a tape

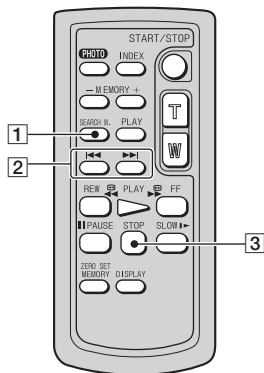

## Note

- See page 143 for details on how to use the Remote Commander.

## Searching for a scene by date of recording (Date search)

You can locate the point where the recording date changes.

**1** Set the POWER switch to VCR.

**2** Press SEARCH M. **1** on the Remote Commander repeatedly to select [DATE SEARCH].

**3** Press **◀◀** (previous)/**▶▶** (next) **2** on the Remote Commander to select a recording date.

You can select the previous or the next date of the present point on the tape.

Playback starts automatically from the point where the date changes.

## To cancel the operation

Press STOP **3** on the Remote Commander.

## Notes

- If one day's recording is less than 2 minutes, your camcorder may not accurately find the point where the recording date changes.
- The Date search will not function correctly when there is a blank section between recorded sections on the tape.

## Searching for a recording start point (Index search)

You can locate the point where an index signal is recorded (p. 50).

**1** Set the POWER switch to VCR.

**2** Press SEARCH M. **1** on the Remote Commander repeatedly to select [INDEX SEARCH].



---

### 3 Press I◀◀ (previous)/▶▶I (next) [2] on the Remote Commander to select an index point.

You can select the index signal of the point that you want to start playing back the tape.

Playback starts automatically from the point where the selected index signal is recorded.

---

### To cancel the operation

Press STOP [3] on the Remote Commander.

#### 🔗 Notes

- If index recording is less than 2 minutes, your camcorder may not accurately find the index point.
- The Index search will not function correctly when there is a blank section between recorded sections on the tape.

# Playing the picture on a TV

Connection methods and image quality differ depending on what type of TV is connected and connectors used.

Use the supplied AC Adaptor to obtain AC power (p. 22).

Refer also to the instruction manuals supplied with the device to be connected.

## Selecting the connection method according to your TV type and connectors

### High definition TV

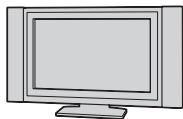

#### HD (high definition) image quality\*

- An HDV formatted picture is played back as it is (HD image quality).
- A DVCAM (DV) formatted picture is played back as it is (SD image quality).

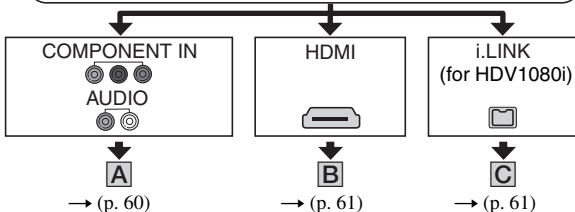

### 16:9 (wide) or 4:3 TV

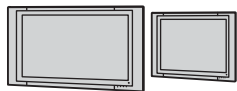

#### SD (standard definition) image quality\*

- An HDV formatted picture is down converted to DVCAM (DV) format (SD image quality) and played back.
- A DVCAM (DV) formatted picture is played back as it is (SD image quality).

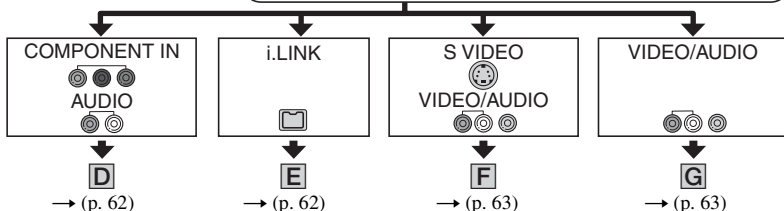

## Notes

- Make all menu settings on your camcorder before connecting. The TV may not recognize the video signal properly when changing [VCR HDV/DV] and [i.LINK CONV] settings after connecting with an i.LINK cable.
- \* Pictures recorded in the DVCAM (DV) format are played back as SD (standard definition) images regardless of the connection.

## Playing the picture on a TV (Continued)

### Jacks on your camcorder

Open the jack cover and connect the cable.

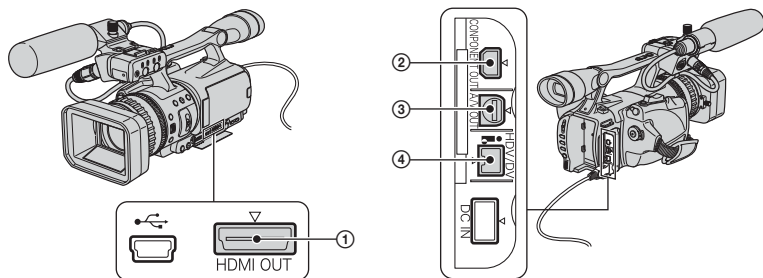

### Connecting to a high definition TV

: Signal flow

Type	Camcorder	Cable	TV	Menu Setting
<b>A</b>	<p>②</p>	<p>Component video cable (supplied)</p>	<p>COMPONENT VIDEO IN</p>	<p> (IN/OUT REC) menu →            [VCR HDV/DV] →            [AUTO] (p. 82)            [COMPONENT] →            [1080i/576i] (p. 83)</p>
	<p>③</p>	<p>A/V connecting cable (supplied)</p>	<p>AUDIO</p>	

#### **Note**

- An A/V connecting cable is also needed to output audio signals. Connect the white and red plugs of the A/V connecting cable to the audio input jack of your TV.

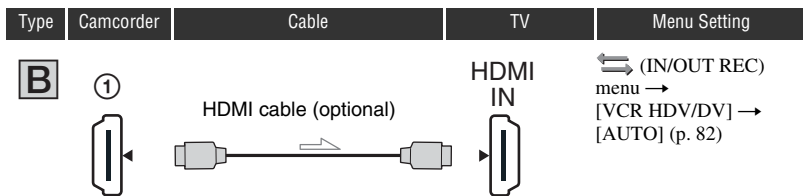

### ⓘ Notes

• **Use an HDMI cable with the HDMI logo.**

- Pictures in the DVCAM (DV) format are not output from the HDMI OUT jack, if copyright protection signals are recorded in the pictures.
- DVCAM (DV) format pictures input to the camcorder via i.LINK cable (p. 96) cannot be output.
- Your TVs may not function correctly (for example, no sound or image). Do not connect the HDMI OUT jack of your camcorder and HDMI OUT jack of the external device with the HDMI cable. This may cause a malfunction.

### 💡 Tip

- HDMI (High Definition Multimedia Interface) is an interface to send both video and audio signals. Connecting HDMI OUT jack to an external device supplies high quality images and digital audio to you.

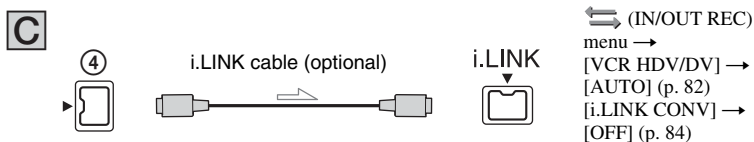

### ⓘ Notes

• **Your TV needs to have an i.LINK jack compatible with HDV1080i. For details, confirm the specifications of your TV.**

- If your TV is not compatible with HDV1080i, connect your camcorder and TV with the supplied component video cable and A/V connecting cable as illustrated in **A**.
- The TV needs to be set so that it recognizes that the camcorder is connected. See the instruction manuals supplied with your TV.
- This camcorder has a 4-pin i.LINK terminal. Select a cable that fits the terminal on the device to be attached.

## Playing the picture on a TV (Continued)

### Connecting to a 16:9 (wide) or 4:3 TV

#### To set the aspect ratio according to the connected TV (16:9/4:3)

Change [DOWN CONVERT] setting to match your TV (p. 84).

#### Note

- When you play back a tape recorded in the DVCAM (DV) format on a 4:3 TV not compatible with the 16:9 signal, set [DV WIDE REC] to [OFF] on your camcorder when recording a picture (p. 83).

#### Tip

- When your TV is monaural (When your TV has only one audio input jack), connect the yellow plug of the A/V connecting cable to the video input jack and connect the white (left channel) or the red (right channel) plug to the audio input jack of your TV or VCR. When you want to play the sound in monaural mode, use a connecting cable for that purpose.

 : Signal flow

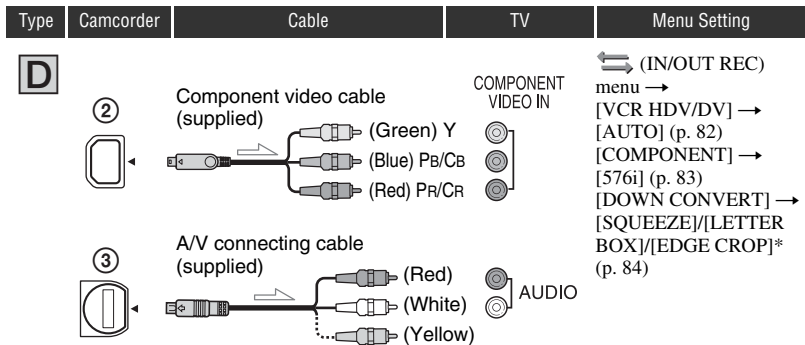

#### Note

- A/V connecting cable is also needed to output audio signals. Connect the white and red plugs of the A/V connecting cable to the audio input jack of your TV.

### E

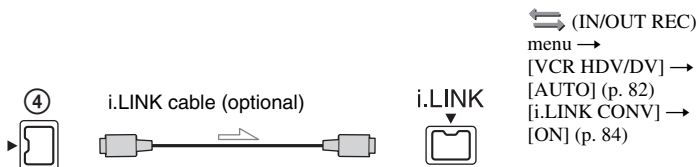

#### Notes

- The TV needs to be set so that it recognizes that the camcorder is connected. See the instruction manuals supplied with your TV.
- This camcorder has a 4-pin i.LINK terminal. Select a cable that fits the terminal on the device to be attached.

Type	Camcorder	Cable	TV	Menu Setting
------	-----------	-------	----	--------------

**F**

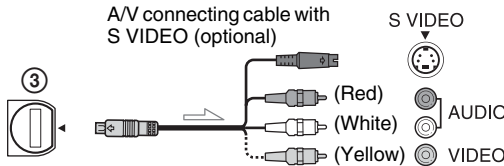

↔ (IN/OUT REC)  
 menu →  
 [VCR HDV/DV] →  
 [AUTO] (p. 82)  
 [DOWN CONVERT] →  
 [SQUEEZE]/[LETTER  
 BOX]/[EDGE CROP]\*  
 (p. 84)

**Notes**

- When connecting only an S VIDEO plug (S VIDEO channel), audio signals are not output. To output audio signals, connect the white and red plugs of the A/V connecting cable with an S VIDEO cable to the audio input jack of your TV.
- This connection produces higher resolution pictures compared with the A/V connecting cable (Type **G**).

**G**

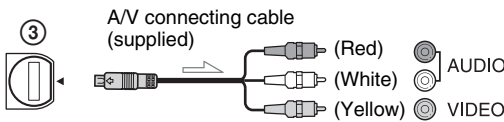

↔ (IN/OUT REC)  
 [VCR HDV/DV] →  
 [AUTO] (p. 82)  
 [DOWN CONVERT] →  
 [SQUEEZE]/[LETTER  
 BOX]/[EDGE CROP]\*  
 (p. 84)

\* Change the settings according to the TV connected.

**Notes**

- If you connect your camcorder to your TV using more than one type of cable to output images from a jack other than the i.LINK jack, the order of priority of the output signals is as follows:  
 HDMI → component video → S VIDEO → audio/video.
- See page 128 for the details of i.LINK.

**When connecting to your TV via a VCR**

Select the connecting method on page 92 depending on the input jack of the VCR. Connect your camcorder to the LINE IN input on the VCR using the A/V connecting cable. Set the input selector on the VCR to LINE (VIDEO 1, VIDEO 2, etc.).

**If your TV/VCR has a 21-pin adaptor (EUROCONNECTOR)**

Use a 21-pin adaptor (optional) to view playback pictures.

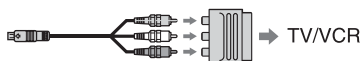

# Using the menu items

You can change various settings or make detailed adjustments using the menu items displayed on the screen.

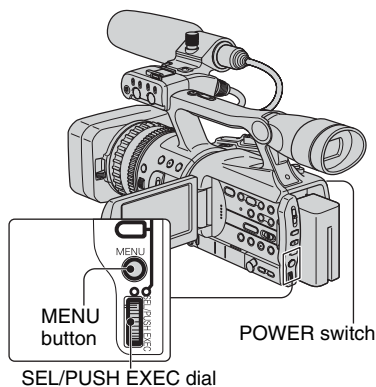

**1** While pressing the green button, set the POWER switch.

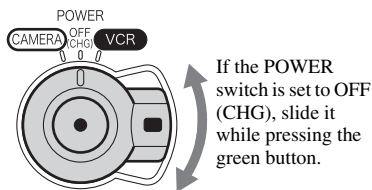

**2** Press the MENU button to display the menu index screen.

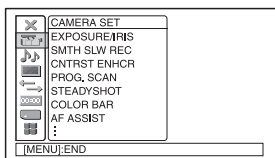

**3** Select the icon of the desired menu by turning the SEL/PUSH EXEC dial, then press the dial.

- CAMERA SET (p. 69)
- AUDIO SET (p. 75)
- DISPLAY SET (p. 77)
- IN/OUT REC (p. 82)
- TC/UB SET (p. 85)
- MEMORY SET (p. 87)
- OTHERS (p. 89)

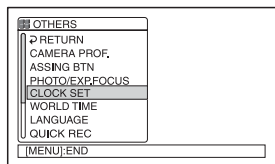

**4** Select the desired item by turning the SEL/PUSH EXEC dial, then press the dial.

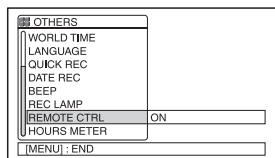

The available menu items vary depending on the power mode of your camcorder. Unavailable items will be grayed out.



- 
- 5** Select the desired setting by turning the SEL/PUSH EXEC dial, then press the dial.

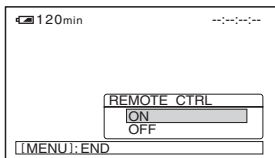

- 
- 6** Press the MENU button to hide the menu screen.

To return to the previous screen, select [↶ RETURN].

---

# Menu items

Available menu items (●) vary depending on the POWER switch position.

Position of POWER switch:

CAMERA

VCR



## (CAMERA SET) menu (p. 69)

EXPOSURE/IRIS	●	—
SMTH SLW REC	●	—
CNTRST ENHCR	●	—
PROG. SCAN	●	—
STEADYSHOT	●	—
COLOR BAR	●	—
AF ASSIST	●	—
FOCUS MACRO	●	—
AE SHIFT	●	—
AE RESPONSE	●	—
AGC LIMIT	●	—
AT IRIS LMT	●	—
ATW SENS	●	—
FLCKR REDUCE	●	—
HANDLE ZOOM	●	—
SHOT TRANS	●	—
INTERVAL REC	●	—
DV FRAME REC <small>DVCAM DV 2</small>	●	—
BACK LIGHT	●	—
SPOTLIGHT	●	—
HYPER GAIN	●	—
D.EXTENDER	●	—
FADER	●	—















## (AUDIO SET) menu (p. 75)

DV AU. MODE <small>DVCAM DV 2</small>	●	—
MIC NR	●	—
XLR SET	●	—
AUDIO CH SEL	—	●
DV AUDIO MIX <small>DVCAM DV 2</small>	—	●



## (DISPLAY SET) menu (p. 77)

PEAKING	●	—
HISTOGRAM	●	—
MARKER	●	—
EXP.FOCUS TYPE	●	—
ALLSCAN MODE	●	—
CAM DATA DSP	●	—
AU.LVL DISP	●	—
ZOOM DISPLAY	●	—
FOCUS DISP	●	—
SHUTTER DISP	●	—

	Position of POWER switch:	
	CAMERA	VCR
LCD BRIGHT	●	●
LCD COLOR	●	●
LCD BL LEVEL	●	●
VF B.LIGHT	●	●
VF COLOR	●	●
VF POWERMODE	●	●
DATA CODE	-	●
LETTER SIZE	●	●
 REMAINING	●	●
DISP OUTPUT	●	●
 <b>(IN/OUT REC) menu (p. 82)</b>		
REC FORMAT	●	-
VCR HDV/DV	-	●
DV REC MODE  	●	●
DV WIDE REC  	●	-
EXT REC CTRL	●	-
COMPONENT	●	●
i.LINK CONV	●	●
DOWN CONVERT	●	●
 <b>(TC/UB SET) menu (p. 85)</b>		
TC PRESET	●	●
UB PRESET	●	●
TC RUN	●	●
TC MAKE	●	●
TC LINK	●	-
TC/UB DISP	●	●
UB TIME REC	●	●
 <b>(MEMORY SET) menu (p. 87)</b>		
 QUALITY	●	●
 ALL ERASE	-	●
 FORMAT	●	●
FILE NO.	●	●
NEW FOLDER	●	●
REC FOLDER	●	●
PB FOLDER	-	●
 <b>(OTHERS) (p. 89)</b>		
CAMERA PROF.	●	●
ASSIGN BTN	●	●
PHOTO/EXP.FOCUS	●	●
CLOCK SET	●	●

## Menu items (Continued)

	Position of POWER switch:	
	CAMERA	VCR
WORLD TIME	●	●
LANGUAGE	●	●
USB SELECT	—	●
PB ZOOM	—	●
QUICK REC 	●	—
DATE REC	●	—
BEEP	●	●
REC LAMP	●	—
REMOTE CTRL	●	●
HOURS METER	●	●

# (CAMERA SET) menu

Settings to adjust your camcorder to the recording conditions (EXPOSURE/IRIS/STEADYSHOT/BACK LIGHT, etc.)

The default settings are marked with ►. The indicators in parentheses appear when the items are selected.

See page 64 for details on selecting menu items.

Press the MENU button → select the  (CAMERA SET) by turning the SEL/PUSH EXEC dial.

## EXPOSURE/IRIS

### ■ DIAL ASSIGN

You can select assign settings with the EXPOSURE/IRIS dial from [EXPOSURE1] (the default settings), [EXPOSURE2], [IRIS] and [AE SHIFT](p. 39).

### 🔔 Note

- If you change the settings assigned to the EXPOSURE/IRIS dial, existing manual values are changed back to automatic values.

### ■ DIAL SENS

You can select the EXPOSURE/IRIS dial sensitivity from [HIGH], [MIDDLE] (the default settings) or [LOW].

### ■ DIAL ROTATE

You can select the rotation direction of the EXPOSURE/IRIS dial.

#### ► NORMAL

You can change the screen brightness by turning the dial up.

#### OPPOSITE

You can change the screen brightness by turning the dial down.

## SMTH SLW REC (Smooth slow recording)

Fast moving subjects and actions, which cannot be captured under the general recording conditions, can be recorded in smooth moving slow-motion.

This is useful for recording fast actions such as a golf or tennis swing.

### ① Set [REC TIME].

Select the recording time from [3sec] (the default setting), [6sec] and [12sec].

The picture quality deteriorates as the recording time increases.

### ② Set [REC TIMING].

Select the recording timing from [START TRIGGR] and [END TRIGGR] to record the action after or before the REC START/STOP button is pressed.

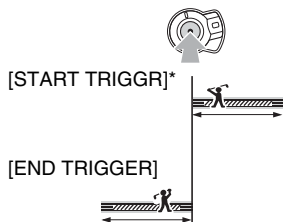

\* The default setting is [START TRIGGR].

### ③ Start recording.

Select [EXECUTE], then press the REC START/STOP button on the [SMTH SLW REC] screen.

A slow-motion movie about 4 times longer than your [REC TIME] setting is recorded. Recording ends when [Recording...] disappears from the screen.

To cancel [SMTH SLW REC], press the MENU button

Press the MENU button → select the  (CAMERA SET) by turning the SEL/PUSH EXEC dial.

## 🔌 Notes

- Sounds cannot be recorded
- [SMTH SLW REC] settings are automatically canceled if you turn the power off and back on.
- The shutter speed is automatically set to 1/215 even if you set it to a speed slower than 1/215.
- The recording time may be shorter than the set time, depending on recording conditions.
- The image quality is lower than with the regular recording.

## CNTRST ENHCR

When you set [CNTRST ENHCR] to [ON], high contrast images, such as backlit scene images, are detected and unexposed shadows of the images are automatically reduced (the default setting is [OFF]).

## 🔌 Note

- When you set [BACK LIGHT] to [ON], [CNTRST ENHCR] is temporarily turned off.

## PROG. SCAN

You can shoot progressive movies with a vertical resolution of 1,080 lines.

### ▶ OFF

#### 25 (25pSCAN)

Select to shoot 25 frames per second, which is the same as cinema films.

## 🔌 Note

- Shot movies are converted to the 50i format and stored.

## STEADYSHOT

### ■ ON/OFF

You can compensate for camera shake (the default setting is [ON]). Set [ON/OFF] to [OFF] () when using a tripod (optional), then the image becomes natural.

### ■ TYPE

You can select the type of the SteadyShot function that compensates for camera-shake.

#### HARD

Select to activate the SteadyShot function with stronger effect. This mode is not recommended for recording with camera pan, tilt technique.

#### ▶ STANDARD

Select to activate the standard SteadyShot function.

#### SOFT

Select to activate the SteadyShot function so that it leaves a slight unsteadiness on the picture so the picture looks natural.

#### WIDE CONV.

Select when a wide conversion lens (optional) is attached. This mode is the most effective with Sony VCL-HG0862K wide conversion lens.

## COLOR BAR

### ■ ON/OFF

You can display the color bar or record it on the tape by setting to [ON]. It is convenient to adjust the color on the connected monitor (the default setting is [OFF]).

## 🔌 Note

- This is automatically set to [OFF] the next time you switch on the camcorder.

## TYPE

You can select the color bar type.

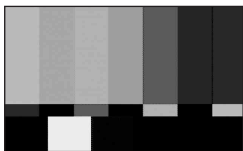

TYPE 1

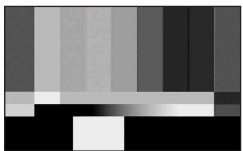

TYPE 2

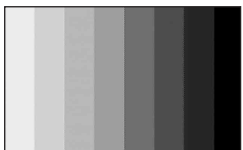

TYPE 3

## TONE

When you set [ON/OFF] to [ON] and [TONE] to [ON], audio tone signals (1kHz: full bit -18dB) are output (the default setting is [OFF]).

## AF ASSIST

When you set [AF ASSIST] to [ON], you can briefly focus manually by turning the focus ring during the auto focus. (the default setting is [OFF]).

## FOCUS MACRO

Since the default setting is [ON], you can focus on a subject within 80 cm (about 2 5/8 feet). When [FOCUS MACRO] is set to [OFF] (OFF), you cannot focus on a subject within 80 cm (about 2 5/8 feet) but you can easily find the focal point of a subject at 80 cm (about 2 5/8 feet) or further regardless of the zoom position.

## AE SHIFT

You can adjust the exposure between -7 (dark) and +7 (bright) using the SEL/PUSH EXEC dial. **AS** and the setting value appear when [AE SHIFT] is set to anything other than the default setting.

### Notes

- If you adjust all of the iris, gain, shutter speed manually, you cannot obtain the effect of [AE SHIFT].
- This function is not effective when [HYPER GAIN] is set.

## AE RESPONSE

You can select the speed to adjust the exposure automatically, in accordance with the brightness of the subject. [FAST], [MIDDLE], and [SLOW] are available (the default setting is [FAST]).

## AGC LIMIT

You can select the upper limit for the Auto Gain Control (AGC) from [OFF] (18dB, the default setting), [12dB], [6dB] or [0dB].

### Note

- If you adjust the gain manually, you cannot obtain the effect of [AGC LIMIT].

## AT IRIS LMT

You can select the highest iris value for the automatic adjustment from [F1 1] (the default settings), [F5.6], [F4].

Press the MENU button → select the  (CAMERA SET) by turning the SEL/PUSH EXEC dial.

## Note

- If you adjust the iris manually, you cannot obtain the effect of [AT IRIS LMT].

## ATW SENS

You can set the auto white balance operation under a reddish light source such as an incandescent lamp or candle, or under a blueish light source such as in outdoor shade.

### ▶ INTELLIGENT

Adjustment is automatically performed to achieve a natural atmosphere according to the brightness of the scene.

### HIGH

Redness or blueness will decrease.

### MIDDLE

### LOW

Redness or blueness will increase.

## Notes

- This is only effective when white balance is adjusted automatically.
- [ATW SENS] is not effective under a clear sky or the sun.

## FLCKR REDUCE

### ▶ ON

Select to record under normal conditions. Flickering of the screen under a light source such as fluorescent lamps will be reduced.

### OFF

Select when you do not want to reduce flickering of the screen.

## Note

- Flickering may not be reduced depending on the light sources.

## HANDLE ZOOM

You can change the zoom speed of handle zoom switch positions H and L (p. 37).

### ■ H

You can select the zoom speed of position H of the handle zoom switch from 1 (slow) through 8 (fast) (the default setting is 6).

### ■ L

You can select the zoom speed of position L of the handle zoom switch from 1 (slow) through 8 (fast) (the default setting is 3).

## SHOT TRANS

You can set [TRANS TIME], [TRANS CURVE], [START TIMER] and [REC LINK]. See page 52 for details on using the shot transition function.

### ■ TRANS TIME

You can select transition time ([3.5sec] to [15.0sec], the default setting is [4.0sec]).

### ■ TRANS CURVE

You can select the transition curve. The transition curve changes as follows.

\*1: parameter level

\*2: transition of time

### LINEAR

Make the transition linearly.

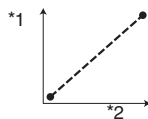

### ▶ SOFT STOP

Make the transition slowly at the end.

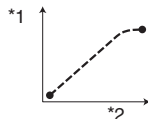



## SOFT TRANS

Make the transition slowly at the beginning and end, and linearly in between.

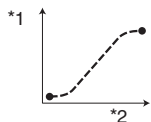

### Note

- You cannot change [TRANS TIME] and [TRANS CURVE] settings during store, check, or execution of [SHOT TRANS]. Cancel [SHOT TRANS] setting by pressing the ASSIGN button 1 several times before changing [TRANS TIME] or [TRANS CURVE] setting.

## START TIMER

You can set the timer for starting the shot transition. You can select the time from [5sec], [10sec] and [20sec] (the default setting is [OFF]).

## REC LINK

### OFF

Select not to start transition when the recording is started.

### SHOT-A

Select to start transition to SHOT-A when the recording is started.

### SHOT-B

Select to start transition to SHOT-B when the recording is started.

## INTERVAL REC

You can record a series of movies on a tape at regular intervals. This function is useful to observe things like cloud movements or daylight changes. The scenes run smoothly into each other when you play back the tape. Use the AC Adapter/Charger to obtain AC power for long recording.

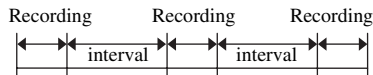

- Select [ON/OFF] → [ON] with the SEL/PUSH EXEC dial.
- Perform the following step if you are changing the recording time from the default setting of [0.5sec]. If you are keeping the default recording time, go straight to step ③.  
Select [REC TIME] → [0.5sec], [1sec], [1.5sec] or [2sec] with the SEL/PUSH EXEC dial.
- Perform the following step if you are changing the interval time from the default setting of [30sec]. If you are keeping the default interval time, go straight to step ④.  
Select [INTERVAL] → [30sec], [1min], [5min] or [10min]
- Select [OK] with the SEL/PUSH EXEC dial.
- Press the MENU button to hide the menu screen.
- Press the REC START/STOP button.  
The [INTERVAL REC] recording starts.

To cancel [INTERVAL REC], press the REC START/STOP button.

The operation of your camcorder differs depending on when you press the REC START/STOP button.

If you press the button during [INTERVAL REC] recording, the recording temporarily stops, then if you press it again, the [INTERVAL REC] recording restarts.

If you press the button during [INTERVAL REC] interval, the [INTERVAL REC] recording stops and regular recording starts, then if you press it again, regular recording stops. If you press the button once again, the [INTERVAL REC] recording restarts.

To cancel the [INTERVAL REC] recording, select [ON/OFF] → [OFF] with the SEL/PUSH EXEC dial.

### Notes

- The recording time and interval time may differ slightly from the settings.
- If you focus manually, you can get sharp images even if the lighting changes.
- You can disable the operation sound by setting [BEEP] to [OFF] (p. 91).

Press the MENU button → select the  (CAMERA SET) by turning the SEL/PUSH EXEC dial.

## DV FRAME REC

You can record pictures with a stop-motion animated effect by alternately recording a few frames and then moving the subject a little. Operate your camcorder using the Remote Commander to prevent camera shake.

### ▶ OFF

Select to record in the standard recording mode.

### ON

Select to record pictures using the DV FRAME REC function.

- ① Select [ON] by the SEL/PUSH EXEC dial.
- ② Press the MENU button to hide the menu screen.
- ③ Press the REC START/STOP button.  
A picture (approximately 5 frames) is recorded, and your camcorder enters the standby mode.
- ④ Move the subject and repeat step 3.

### Note

- When you use frame recording continuously, the remaining tape time will not be indicated correctly.
- The last scene will be longer than other scenes.
- You cannot record index signals during frame recording.
- This is automatically set to [OFF] if you turn the power off and back on.

## BACK LIGHT

When you set [BACK LIGHT] to [ON],  is displayed and the back light function is enabled (the default setting is [OFF]).

### Notes

- The back light function is canceled when you set [SPOTLIGHT] to [ON].
- You cannot use the back light function if 2 or more items out of iris, gain, and shutter speed are adjusted manually.

## SPOTLIGHT

When you set [SPOTLIGHT] to [ON] () , you can reduce overexposed highlights on faces of people who are under strong light, such as on a stage, during recording (the default setting is [OFF]).

### Notes

- The spotlight function is canceled when you set [BACK LIGHT] to [ON].
- You cannot use the spotlight function if 2 or more items out of iris, gain, and shutter speed are adjusted manually.

## HYPER GAIN

When you set [HYPER GAIN] to [ON] () , you can increase the gain to about 36 dB (the default setting is [OFF]).

### Notes

- During the hyper gain, you cannot use the following function.
  - [BACK LIGHT]
  - [SPOT LIGHT]
- During the hyper gain, the picture quality will be reduced due to noise.
- [HYPER GAIN] is automatically set to [OFF] if you turn the power off and back on.

### Tip

- You are recommended to use this function with manual focus.

## D.EXTENDER (Digital Extender)

When you set [D.EXTENDER] to [ON] () , the image is displayed about 1.5 times larger. The picture quality deteriorates due to the digital process. You can enlarge images of distant subjects such as wild birds (the default setting is [OFF]).

### Note

- This is automatically set to [OFF] if you turn the power off and back on.

## FADER

You can record a transition with the following effects adding to the interval between scenes.

- 1 Select the desired effect in [STBY] (during fading in) or [REC] (during fading out) mode.
- 2 Press the REC START/STOP button.  
The fader indicator stops flashing and disappears when the fade is complete.

To cancel before starting the operation, select [OFF] in step ①.  
Once you press the REC START/STOP button, the setting is canceled.



### WHITE FADER



### BLACK FADER



#### Note

- This is automatically set to [OFF] if you turn the power off and back on.

## (AUDIO SET) menu

Settings for the audio recording (DV AU. MODE/XLR SET, etc.)

The default settings are marked with ►. The indicators in parentheses appear when the items are selected.

**See page 64 for details on selecting menu items.**

Press the MENU button → select the ► (AUDIO SET) by turning the SEL/PUSH EXEC dial.

## DV AU. MODE (DV Audio mode) DVCAM DV SE

### ► FS32K (32k)

Records in the 12-bit mode (2 stereo sounds).

### FS48K (48k)

Records in the 16-bit mode (1 stereo sound with high quality).

#### Note

- When recording in the HDV format, sound is automatically recorded in the [FS48K] mode.

## MIC NR

Since the default setting is [ON], noise input through the microphone is reduced.

## XLR SET

### ■ AU. MAN GAIN

You can select whether the audio levels of channel 1 is linked with or separated from that of channel 2 when using an external microphone.

#### ► SEPARATE

Select to record the sound in channel 1 separately from that in channel 2 (to use channel 1 and channel 2 as separate sound source).

#### LINKED

Select to record the sound in channel 1 and that in channel 2 (as a set, like stereo sound).

[ ] appears on the status check screen.

Press the MENU button → select the  (AUDIO SET) by turning the SEL/PUSH EXEC dial.

## 🔊 Notes

- This function is effective only when the AUTO/MAN switches of both CH1 and CH2 are set to MAN (p. 48).
- When [LINKED] is set, you can adjust the volume with the AUDIO LEVEL dial of CH1 (p. 48).
- You cannot change the audio levels of CH1 and CH2 individually even if you set [SEPARATE] when audio input from the INPUT1 jack is recorded simultaneously to CH1 and CH2.

### ■ INPUT1 LEVEL

You can switch between microphone and line for input from the INPUT1 jack.

#### ▶ MIC

Select to input audio signals from an external microphone through the INPUT1 jack.

 appears on the status check screen.

#### LINE

Select to input audio signals from an audio device through the INPUT1 jack.

 appears on the status check screen.

### ■ INPUT1 TRIM

You can adjust levels of signal input from the INPUT1 jack. This function is effective only when [INPUT1 LEVEL] is set to [MIC].

You can select from [0dB], [-8dB] and [-16dB] (the default setting is [0dB]).

### ■ INPUT1 WIND

This function is effective only when [INPUT1 LEVEL] is set to [MIC].

#### ▶ OFF

Select to disable wind noise reduction.

#### ON

Select to enable wind noise reduction.

 appears on the status check screen.

### ■ INPUT2 LEVEL

You can switch between microphone and line for input from the INPUT2 jack.

#### ▶ MIC

Select to input audio signals from an external microphone through the INPUT2 jack.

 appears on the status check screen.

#### LINE

Select to input audio signals from an audio device through the INPUT2 jack.

 appears on the status check screen.

### ■ INPUT2 TRIM

You can adjust levels of signal input from the INPUT2 jack. This function is effective only when [INPUT2 LEVEL] is set to [MIC].

You can select from [0dB], [-8dB] and [-16dB] (the default setting is [0dB]).

### ■ INPUT2 WIND

This function is effective only when [INPUT2 LEVEL] is set to [MIC].

#### ▶ OFF

Select to disable wind noise reduction.

#### ON

Select to enable wind noise reduction.

 appears on the status check screen.

## 💡 Tips

- The INPUT TRIM function adjusts the input level from an external microphone. When using a highly sensitive microphone or recording loud sound, set this to the minus side. When using a less sensitive microphone or recording quiet sound, set it to the plus side.
- When recording loud sound, the sound may be distorted at either the input point or the recording point. If it is distorted at the input point, adjust the sound using the INPUT TRIM function. If it is distorted at the recording point, lower the total volume level manually.
- If you set INPUT TRIM too far to the minus side, the microphone volume becomes too low, resulting in a poor signal to noise ratio.
- Test the effect of the INPUT TRIM function according to the microphone used or the sound field of the recording site before actual recording.

**AUDIO CH SEL****▶ CH1,CH2**

Select to output sound of CH1 and CH2 from respective channels.

**CH1**

Select to output sound of CH1 from channel 1/2.

**CH2**

Select to output sound of CH2 from channel 1/2.

**💡 Tip**

- When you select [CH1,CH2] and output from the stereo of your camcorder, sound is mixed sound of CH1 and CH2.

**DV AUDIO MIX**  

You can monitor the sound recorded on the tape with audio dubbing or 4ch microphone recording during playback.

You can select the channel from which the dubbed sound is outputted during playback.

**▶ CH1,CH2**

Select to output only the originally recorded sound (CH1, CH2).

**MIX**

Select to synthesize and output the originally recorded sound (CH1, CH2) and the sound added afterwards (CH3, CH4).

**CH3,CH4**

Select to output only the sound added afterwards.

 **(DISPLAY SET)****menu**

Display settings of the display and the viewfinder (MARKER/VF B.LIGHT/DATA CODE, etc.)

The default settings are marked with ▶. The indicators in parentheses appear when the items are selected.

**See page 64 for details on selecting menu items.**

Press the MENU button → select the  (DISPLAY SET) by turning the SEL/PUSH EXEC dial.

**PEAKING****■ ON/OFF**

When you set to [ON], the outline of the subject on the screen is enhanced for easier focusing. (the default setting is [OFF]).

**■ COLOR**

[WHITE], [RED], [YELLOW] are available for the outline color. (the default setting is [WHITE].)

**■ LEVEL**

[HIGH], [MIDDLE], [LOW] are available for the outline level. (the default setting is [MIDDLE].)

**🔊 Note**

- The image with enhanced outline is not recorded on the tape.

**💡 Tip**

- This makes focusing easier when used with expanded focus display (p. 39).

Press the MENU button → select the  (DISPLAY SET) by turning the SEL/PUSH EXEC dial.

## HISTOGRAM

When you set [HISTOGRAM] to [ON], [HISTOGRAM] (a graph to display a distribution of tones in your picture) window appears on the screen (the default setting is [OFF]).

This item is useful when you adjust exposure. You can adjust EXPOSURE/IRIS while checking [HISTOGRAM] window (p. 39). [HISTOGRAM] will not be recorded on a tape or “Memory Stick Duo.”

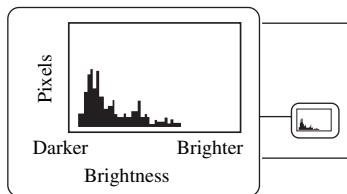

### 💡 Tips

- The left area on the graph shows the darker areas of the picture while the right area shows the brighter areas.
- If you set ZEBRA to 70 or 100, the guide is displayed (p. 41).

## MARKER

When you set [ON/OFF] to [ON], you can display [CENTER], [ASPECT], [SAFETY ZONE] and [GUIDEFAME] markers

### ■ ON/OFF

When you select [ON], markers are displayed (the default setting is [OFF]). The markers are not recorded

### ■ CENTER

When you set [CENTER] to [ON], the marker is displayed at the center of the screen (the default setting is [ON]).



### ■ ASPECT

You can select whether to display the markers at an aspect of [4:3], [13:9], [14:9] or [15:9] (the default setting is [OFF]).



### ■ SAFETY ZONE

When you select [80%] or [90%], the marker indicating the area that can be displayed on a regular home TV screen is displayed (the default setting is [OFF]).



### ■ GUIDEFAME

When you set [GUIDEFAME] to [ON], the marker for checking the horizontal and vertical positions of the subject is displayed (the default setting is [OFF]).



### 🔊 Notes

- Screen indicators are not output from the analog jacks when a marker is displayed.
- You can only display [14:9], [15:9] and [90%] when [ALLSCAN MODE] is set to [ON].
- When [DATE REC] is set to [ON], you cannot display markers.

### 💡 Tips

- You can display all types of markers at the same time.
- You can obtain a balanced composition by positioning the subject at the cross points of the guideframe marker.
- Markers are displayed only on the LCD panel and viewfinder (they are not output from the jacks).

## EXP.FOCUS TYPE

You can set a type of the expanded focus display.

### ▶ TYPE 1

Simply enlarges images.

## TYPE 2

Enlarges and shows images in white and black.

### ALLSCAN MODE

When you set [ALLSCAN MODE] to [ON], you can check the area surrounding the picture frame, which you cannot check on a TV screen (the default setting is [OFF]). During the simple all scan display, a black frame appears around the screen. Set to [OFF] to return to the previous screen.

### CAM DATA DSP (Camera data display)

When you set [CAM DATA DSP] to [ON], the iris, shutter speed, and gain settings are constantly displayed (the default setting is [OFF]).

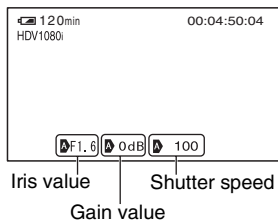

#### Tips

- When set to manual, the values are displayed regardless of the camera data display settings.
-  indicates auto settings.
- The items displayed by setting [CAM DATA DSP] to [ON] are different from the items that will be displayed when [DATA CODE] is set to [CAMERA DATA] (p. 80).

### AU.LVL DISP (Audio level display)

Since the default setting is [ON], the audio level meter is displayed.

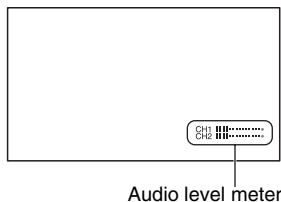

### ZOOM DISPLAY

#### ► BAR

Select to indicate the zoom position with the bar display.

#### NUMBER

Select to indicate the zoom position in numbers (0 through 99).

### FOCUS DISP

You can select how to display the focal distance during manual focus.

#### ► METER

Select to display the focus value in meters.

#### FEET

Select to display the focus value in feet.

### SHUTTER DISP

You can select how to display the shutter speed.

#### ► SECOND

Select to display the shutter speed in seconds.

Press the MENU button → select the  (DISPLAY SET) by turning the SEL/PUSH EXEC dial.

## DEGREE

Select to display the shutter speed in degrees, where the shutter speed equivalent to the data reading cycle from the image sensor is displayed as 360°.

- When [PROG. SCAN] is set to [OFF], 1/50 is equal to 360°.
- When [PROG. SCAN] is set to [25], 1/25 is equal to 360°.

### Note

- Shutter speeds displayed when [DATA CODE] is set to [CAMERA DATA] are always displayed in seconds

### Tip

- Shutter speed slower than 360° are displayed in multiples of 360°, such as 360° × 2.

## LCD BRIGHT

You can adjust the LCD bright intensity using the SEL/PUSH EXEC dial. The brightness of recorded pictures is not affected.

### Tip

- You can also turn off the LCD backlight (p. 26).

## LCD COLOR

You can adjust the LCD color intensity using the SEL/PUSH EXEC dial. The color of recorded pictures is not affected.

## LCD BL LEVEL

You can adjust the brightness of the LCD screen's backlight.

### ▶ NORMAL

Standard brightness.

### BRIGHT

Brightens the LCD screen.

### Notes

- When you connect your camcorder to outside power sources, [LCD BL LEVEL] is automatically set to [BRIGHT].
- When you select [BRIGHT], the recordable time with the battery is slightly reduced.

## VF B.LIGHT

You can adjust the brightness of the viewfinder.

### ▶ NORMAL

Standard brightness.

### BRIGHT

Brightens the viewfinder screen.

### Notes

- When you connect your camcorder to outside power sources, [BRIGHT] is automatically selected for the setting.
- When you select [BRIGHT], the recordable time with the battery is slightly reduced.

## VF COLOR

### ▶ ON

Displays images in the viewfinder in color.

### OFF

Displays images in the viewfinder in black and white.

## VF POWERMODE

### ▶ AUTO

When the LCD screen is closed or during reverse shooting, the finder is lit.

### ON

The LCD screen and finder are always lit.

## DATA CODE

During playback, you can display the information (data code) recorded automatically at the time of recording is displayed.



## ▶ OFF

Data code is not displayed.

## DATE

Displays the date and time.

## CAMERA DATA

Displays camera setting data.

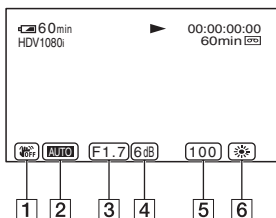

1 SteadyShot off

2 Exposure

**AUTO** is displayed when shooting with automatic adjustment of iris/gain/shutter speed, and **MANUAL** is displayed when shooting with manual adjustment.

3 Iris

**CLOSE** is displayed in the iris value display area when you manually set the iris value to the maximum.

4 Gain

5 Shutter speed

6 White balance

**PWB** is displayed when you play back images recorded using shot transition.

## Notes

- The exposure adjustment value (0EV), the shutter speed, and the iris value appear when still images on a "Memory Stick Duo" are played back.
- In the DATE display, the date and time are displayed in the same area. If you record a picture without setting the clock, [-- -- --] and [--:--:--] will appear.
- If you play back a tape recorded on your camcorder on another device, an incorrect shutter speed may be displayed when the device is set to display camera setting data. The correct shutter speed will be displayed when you play back the tape on your camcorder.

## LETTER SIZE

## ▶ NORMAL

Select to display the menu screen at normal size.

## 2x

Select to display the selected menu item at double the normal height.

## REMAINING

## ▶ AUTO

Displays the remaining tape indicator for about 8 seconds in situations such as those described below.

- When you set the POWER switch to VCR or CAMERA with a cassette inserted.
- When you press ► (Play) or the DISPLAY/BATT INFO button.

## ON

Always displays the remaining tape indicator.

## DISP OUTPUT

## ▶ LCD PANEL

Shows displays such as the time code on the LCD screen and in the viewfinder.

## V-OUT/PANEL

Shows displays such as the time code on the TV screen, LCD screen, and in the viewfinder.

## ⇔ (IN/OUT REC)

### menu

#### Recording settings, input and output settings (VCR HDV/DV/DV REC MODE/ DV WIDE REC/ DOWN CONVERT, etc.)

The default settings are marked with ►. The indicators in parentheses appear when the items are selected.

See page 64 for details on selecting menu items.

Press the MENU button → select the ⇔ (IN/OUT REC) by turning the SEL/ PUSH EXEC dial.

### REC FORMAT

You can select a recording format.

#### ► HDV1080i (HDV1080i)

Records in the HDV1080i specification.

#### DV (DVCAM DV )

Records in the DVCAM (DV) format.

Set [DV REC MODE] when recording in DVCAM (DV) format.

#### Note

- When you output the recording picture using an i.LINK cable, set [i.LINK CONV] (p. 84) accordingly.

### VCR HDV/DV

You can select the playback signal.

Normally select [AUTO].

When your camcorder is connected to another device using an i.LINK cable, select the signal to input/output from the  HDV/DV interface (i.LINK). The selected signal is recorded or played back.

#### ► AUTO

Switches the signals between HDV and DVCAM (DV) formats automatically when playing back a tape.

During i.LINK connection, switches the signals between HDV and DVCAM (DV) formats automatically, and inputs/outputs from the  HDV/DV interface (i.LINK).

#### HDV (HDV1080i)

Plays back only the portions recorded in HDV format.

During i.LINK connection, inputs/outputs only HDV formatted signals from the , HDV/DV interface (i.LINK), and records/plays back. You can also select this when connecting the camcorder to a computer, etc.

#### DV (DV)

Plays back only the portions recorded in DVCAM (DV) format.

During i.LINK connection, inputs/outputs only DVCAM (DV) formatted signals from the , HDV/DV interface (i.LINK), and records/plays back. You can also select this when connecting the camcorder to a computer, etc.

#### Notes

- Disconnect the i.LINK cable before changing [VCR HDV/DV] setting. Otherwise, the connected device, such as a VCR, may not be able to recognize the video signal from your camcorder.
- When [AUTO] is selected and the signal switches between HDV and DVCAM (DV) formats, the picture and sound are interrupted temporarily.
- When [i.LINK CONV] is set to [ON], pictures are output as follows:
  - at [AUTO], an HDV signal is converted to the DVCAM (DV) format and output; a DVCAM (DV) signal is output as it is.
  - at [HDV], an HDV signal is converted to the DVCAM (DV) format and output; a DVCAM (DV) signal is not output.
  - at [DV], a DVCAM (DV) signal is output as it is; an HDV signal is not output.

### DV REC MODE (DV Recording mode)

This function is effective only when [REC FORMAT] is set to [DV].

#### ► DVCAM (DVCAM)

Records in the DVCAM format on a tape.

## DV SP (DV SP)

Record in the SP (Standard Play) mode of the DV format to record for a longer time on a tape than in the DVCAM format.

### Notes

- If you record in the DV SP mode, a mosaic-like disturbance of picture may appear or sound may be interrupted when you play back the tape on other camcorders or VCRs.
- When you mix recordings in the DVCAM mode and in the DV SP mode on one tape, the playback picture may be distorted or the time code may not be continued properly between the scenes.

## DV WIDE REC (DVCAM DV SP)

You can select the aspect ratio for recording according to a type of your TV. Refer also to the instruction manuals supplied with your TV.

### ON

Records pictures in the size that matches the full screen of a 16:9 (wide) TV.

### OFF (4:3)

Records pictures in the size that matches the full screen of a 4:3 TV.

### Notes

- Set [DOWN CONVERT] correctly according to the TV connected for playback (p. 84).
- When you select HDV format, the image size is fixed to 16:9. You cannot record in 4:3 size.

## EXT REC CTRL

You can connect your camcorder to an HDV/DVCAM/DV compatible device (digital HD video camera recorder, digital video camera recorder, hard disc recorder, etc.) with an i.LINK cable, and record movies on your camcorder and the connected device simultaneously, or continue recording from your camcorder to the connected device.

Refer also to the instruction manual supplied with the devices that you are connecting.

### REC CTL MODE

#### OFF

Select not to record on a connected device.

#### SYNCHRONOUS (EXT)

Select to record movies, sound and time code on a connected device in synchronization with your camcorder.

#### RELAY (EXT)

Select to record movies, sound and time code on a connected device when a tape on your camcorder reaches close to the end during recording.

### STBY COMMAND

#### REC PAUSE

Select to be able to stop recording on a connected device and set it to REC PAUSE using the recording stop operation of your camcorder.

#### STOP

Select to be able to stop recording on a connected device by setting it to STOP using the recording stop operation of your camcorder.

## COMPONENT

You can select the type of connection when connecting your camcorder to a TV with the component input jack.

Press the MENU button → select the  (IN/OUT REC) by turning the SEL/PUSH EXEC dial.

## 576i

Select when connecting your camcorder to a TV with the component input jack.

### ▶ 1080i/576i

Select when connecting your camcorder to a TV that has the component input jack and is capable of displaying the 1080i signal.

## i.LINK CONV

### ■ ON/OFF

When you set [i.LINK CONV] to [ON], HDV format signals are converted to DV format signals, and outputted from the  i.LINK interface (i.LINK). DV format signals are outputted without any format conversion (the default setting is [OFF]).

### ■ DOWN CONVERT

You can set an output video signal type from HDV format signals with [i.LINK CONV] set to [ON].

### ▶ SQUEEZE

Select to output a horizontally compressed image while maintaining its original height.

### EDGE CROP

Select to output the central portion of the original image by cropping its right and left edges.

### Notes

- For input signal via an i.LINK connection, see [VCR HDV/DV] (p. 82).
- Disconnect the i.LINK cable before setting [i.LINK CONV]. Otherwise, the connected video device may not be able to recognize the video signal from your camcorder.

## DOWN CONVERT

You can set an output video signal type from HDV format signals.

Use this function for the following outputs.

- COMPONENT (576i)
- S VIDEO
- AUDIO/VIDEO

### ▶ SQUEEZE

Select to output a horizontally compressed image while maintaining its original height.

### LETTER BOX

Select to output an image with black bars added to the top and bottom of the original image, while maintaining the original aspect ratio.

### EDGE CROP

Select to output the central portion of the original image by cropping its right and left edges.

### Notes

- When a movie recorded in the DVCAM (DV) format with [DV WIDE REC] set to [ON] is viewed on a standard 4:3 TV, the images may appear vertically compressed. In this case, set [DV WIDE REC] to [OFF] before recording.

## 00:00 (TC/UB SET) menu

### (TC PRESET/UB PRESET/TC LINK, etc.)

The default settings are marked with ▶. The indicators in parentheses appear when the items are selected.

See page 64 for details on selecting menu items.

Press the MENU button → select the 00:00 (TC/UB SET) by turning the SEL/PUSH EXEC dial.

### TC PRESET

#### ■ PRESET

You can preset the time code.

- ① Select [TC PRESET] by turning the SEL/PUSH EXEC dial, then press the dial.
- ② Select [PRESET] by turning the SEL/PUSH EXEC dial, then press the dial.
- ③ Select the first 2 digits by turning the SEL/PUSH EXEC dial, then press the dial. You can set the time code between 00:00:00:00 and 23:59:59:29.
- ④ Set other digits by repeating step ③.
- ⑤ Select [OK] by turning the SEL/PUSH EXEC dial, then press the dial.

#### ■ RESET

You can reset the time code (00:00:00:00). Select [RESET] in step ① of the [PRESET].

### UB PRESET

#### ■ PRESET

You can preset the user bit.

- ① Select [UB PRESET] by turning the SEL/PUSH EXEC dial, then press the dial.
- ② Select [PRESET] by turning the SEL/PUSH EXEC dial, then press the dial.
- ③ Select the first 2 digits by turning the SEL/PUSH EXEC dial, then press the dial.
- ④ Set other digits by repeating step ③.
- ⑤ Select [OK] by turning the SEL/PUSH EXEC dial, then press the dial.

#### ■ RESET

You can reset the time code (00:00:00:00). Select [RESET] in step ① of the [PRESET].

### TC RUN

You can select how the time code advances.

#### ▶ REC RUN

Time code value advances only while recording. Select this when making the time code continuous at backspace editing.

#### FREE RUN

Time code value advances freely regardless of the camcorder's current operation mode. Select this when adjusting the discrepancy between time code value and real time.

### TC MAKE

#### ▶ REGENERATE

Select to make the time code continuous at backspace editing. Regardless of the [TC RUN] setting, the running mode is automatically set to [REC RUN].

#### PRESET

Select when you do not want to make the time code continuous at backspace editing.

### TC LINK

You can synchronize the time codes of multiple HVR-V1E/V1Ps. This function is useful for editing movies recorded by multiple camcorders.

- ① Decide which camcorder will generate a time code (main camcorder) and which camcorder will receive that time code (sub camcorder). Make sure a tape is loaded in the main camcorder.
- ② Set the POWER switches of the main and sub camcorders to CAMERA.
- ③ Connect the main camcorder to the sub camcorder with an i.LINK cable.

Press the MENU button → select the **00:00** (TC/UB SET) by turning the SEL/PUSH EXEC dial.

- ④ Set the menu items of the main and sub camcorders as follows:
- Set [TC RUN] to [FREE RUN]
  - Set [TC MAKE] to [PRESET]

Set the sub camcorders as follows:

- ⑤ Select [TC/UB SET] → [TC LINK] with the SEL/PUSH EXEC dial.
- ⑥ A message “Synchronize TC with connected device?” is displayed. Select [YES] to synchronize the time code of the sub camcorder to the time code of the main camcorder.

Remove the i.LINK cable when synchronization is completed.

You can record movies with the synchronized time codes.

#### Notes

- If you want to execute [TC LINK] for more than three camcorders, repeat the steps for multiple sub camcorders with one main camcorder.
- Some frame shifting may occur over time after time code synchronization.
- Some frame shifting may occur if you turn the power off and back on. After turning the power off and back on, you are recommended to set [TC LINK] again.

## TC/UB DISP

You can select the time code or the user bit to be displayed on the screen.

### ▶ TC

Select to display the time code (00:00:00:00).

### U-BIT

Select to display the user bit (00 00 00 00).

## UB TIME REC

### ▶ OFF

Select when you do not want to set the user bits to the real time clock.

### ON

Select to set the user bits to the real time clock.

# MEMORY SET

## menu

### Settings for the “Memory Stick Duo” (QUALITY/ALL ERASE, etc.)

The default settings are marked with ►.  
The indicators in parentheses appear when the items are selected.

See page 64 for details on selecting menu items.

Press the MENU button → select the  (MEMORY SET) by turning the SEL/PUSH EXEC dial.

### QUALITY





#### ► FINE (FINE)





Records still images at the fine image quality level.

#### STANDARD (STD)



Records still images at the standard image quality level.

### Capacity of the “Memory Stick Duo” (MB) and the number of recordable pictures

	1.2M 1440 × 810 	0.9M 1080 × 810 	VGA 640 × 480 	0.2M 640 × 360 
16MB	25 60	34 80	96 240	115 240
32MB	51 120	69 160	190 485	240 485
64MB	100 240	135 325	390 980	490 980
128MB	205 490	280 650	780 1970	980 1970
256MB	370 890	500 1150	1400 3550	1750 3550
512MB	760 1800	1000 2400	2850 7200	3600 7200
1GB	1550 3650	2100 4900	5900 14500	7300 14500

	1.2M 1440 × 810 	0.9M 1080 × 810 	VGA 640 × 480 	0.2M 640 × 360 
2GB	3150 7500	4300 10000	12000 30000	15000 30000
4GB	6300 14500	8500 19500	23500 59000	29500 59000

Top: [FINE] is selected for image quality.  
Bottom: [STANDARD] is selected for image quality.

\* Recording: Image size fixed to  1.2M] in HDV or DVCAM (DV) format (16:9) and [0.9M] in DVCAM (DV) format (4:3).  
Playback: Image size is fixed to  1.2M] in HDV format,  0.2M] in DVCAM (DV) format (16:9) and [VGA (0.3M)] in DVCAM (DV) format (4:3).

### Note

- The specifications are for the “Memory Stick Duo” made by Sony Corporation. The number of recordable pictures varies depending on the recording environment.

### Approximate data size of a picture (kB)

	1.2M	0.9M	VGA	0.2M
	600 260	450 190	150 60	130 60

Top: [FINE] is selected for image quality.  
Bottom: [STANDARD] is selected for image quality.

### ALL ERASE

You can delete all the pictures on a “Memory Stick Duo” without image protection, or in the selected folder.

- Select [ALL FILES] or [CURRNT FOLDER].

**[ALL FILES]:** Deletes all the images on the “Memory Stick Duo.”

**[CURRNT FOLDER]:** Deletes all the images in the selected folder.

Press the MENU button → select the  (MEMORY SET) by turning the SEL/PUSH EXEC dial.

② Select [YES] → [YES] by using the SEL/PUSH EXEC dial.

[ Erasing all data...] is displayed.  
[Completed] is displayed when all unprotected images are deleted.

### Notes

- Release the write protect tab on the “Memory Stick Duo” beforehand when using the “Memory Stick Duo” with the write-protect tab (p. 125).
- The folder will not be deleted even when you delete all the pictures in the folder.
- Do not do any of the following while [ Erasing all data...] is displayed:
  - Operate the POWER switch/operation buttons.
  - Eject the “Memory Stick Duo.”

## FORMAT

You do not need to format the “Memory Stick Duo” since it is already formatted at the factory. If you want to format the “Memory Stick Duo,” select [YES]→[YES].

### Notes

- Do not do any of the following while [ Formatting...] is displayed:
  - Operate the POWER switch/operation buttons.
  - Eject the “Memory Stick Duo.”
- Formatting erases everything on the “Memory Stick Duo” including protected image data and newly created folders.

## FILE NO.

### ► SERIES

Assigns file numbers in sequence even if the “Memory Stick Duo” is replaced with another one. The file number is reset when a new folder is created or the recording folder is replaced with another.

### RESET

Resets the file number to 0001 each time the “Memory Stick Duo” is changed.

## NEW FOLDER

When you select [YES], you can create a new folder (102MSDCF to 999MSDCF) on a “Memory Stick Duo.” When a folder is full (a maximum of 9,999 images are stored), a new folder is automatically created.

### Notes

- You cannot delete the created folders using your camcorder. You will have to format the “Memory Stick Duo” (p. 88), or delete them using your computer.
- The number of recordable pictures on a “Memory Stick Duo” may decrease as the number of folders increases.

## REC FOLDER (Recording folder)

You can select the folder to be used for recording by turning the SEL/PUSH EXEC dial, then press the dial.

### Tips

- As the default setting, pictures are saved in the 101MSDCF folder.
- Once you record a picture in a folder, the same folder will be set as the default folder for playback.

## PB FOLDER (Playback folder)

You can select the playback folder by turning the SEL/PUSH EXEC dial, then press the dial.



## (OTHERS) menu

Settings while recording on a tape or other basic settings (USB SELECT/QUICK REC/BEEP, etc.)

The default settings are marked with ►. The indicators in parentheses appear when the items are selected.

See page 64 for details on selecting menu items.

Press the MENU button → select the  (OTHERS) by turning the SEL/PUSH EXEC dial.

### CAMERA PROF. (Camera profile)

You can save up to 20 camera setting profiles on a “Memory Stick Duo” and 2 in your camcorder. Using these saved profiles let you quickly obtain suitable camera settings later. When using multiple camcorders of this model, you can save the setting on a “Memory Stick Duo” and load them into the other camcorders.

#### Tip

- The items that can be saved in the camera profile are set values of the menu, the picture profiles, and the buttons. You can save these set values all in the camera profile.

#### ■ To save camera profile settings

- ① Select [SAVE] by the SEL/PUSH EXEC dial.
- ② Using the SEL/PUSH EXEC dial, select [MEMORY STICK] to save the settings on the “Memory Stick Duo” or [CAMERA] to save the settings in your camcorder.
- ③ Select [NEW FILE] or an existing profile name by turning the SEL/PUSH EXEC dial.
- ④ Select [YES] in the check screen by turning the SEL/PUSH EXEC dial. The camera profile settings are saved.

#### Tips

- If you select [NEW FILE] in [MEMORY STICK], the profile name is [MS01] (when saving the camera profile for the first time).
- If you select [NEW FILE] in [CAMERA], the profile name is [CAM1] or [CAM2].
- If you select an existing camera profile as a destination, the camera profile is overwritten.
- A camera profile saved on “Memory Stick Duo” cannot be viewed or edited on a computer.
- You can copy a camera profile by loading the camera profile stored in your camcorder and saving it onto a “Memory Stick Duo.”

#### ■ To change profile name

You can change the camera profile name.

- ① Select [PROFILE NAME] by the SEL/PUSH EXEC dial.
- ② Select the camera profile that you want to change the name by the SEL/PUSH EXEC dial. [PROFILE NAME] screen appears.
- ③ Change the profile name by turning the SEL/PUSH EXEC dial.

#### Tip

- The method of inputting the name is the same as the method of setting the name of the picture profile (p. 47).
- ④ Select [OK] by turning the SEL/PUSH EXEC dial, then press the dial. Profile name is changed.

#### ■ To load camera profile settings

You can load the camera profile settings and use your camcorder with the settings.

- ① Select [LOAD] by the SEL/PUSH EXEC dial.
- ② Select the camera profile, from which you want to load the settings, by the SEL/PUSH EXEC dial.
- ③ Select [YES] in the check screen. Your camcorder is restarted and the selected camera profile becomes effective.

#### Note

- You cannot load camera profile settings that have been saved by a different model of camcorder or edited on a computer.

Press the MENU button → select the  (OTHERS) by turning the SEL/PUSH EXEC dial.

### ■ To delete camera profile settings

- ① Select [DELETE] by the SEL/PUSH EXEC dial.
- ② Select the camera profile you want to delete by the SEL/PUSH EXEC dial.
- ③ Select [YES] in the check screen.

## ASSIGN BTN

See page 49.

## PHOTO/EXP.FOCUS

You can select a function to assign to the PHOTO/EXPANDED FOCUS button (p. 39).

### ▶ PHOTO

Records a still image (p. 34).

### EXP.FOCUS

The PHOTO/EXPANDED FOCUS button acts the same function as the EXPANDED FOCUS button (p. 39).

### ⚡ Note

- If [EXP.FOCUS] is selected, you cannot record still images with the main unit button. Please use the PHOTO button on the Remote Commander.

## CLOCK SET

See page 28.

## WORLD TIME

When you use your camcorder abroad, you can adjust the clock to the local time by setting the time difference with the SEL/PUSH EXEC dial.

When you set the time difference to 0, the clock returns to the original setting.

## LANGUAGE

You can select the language to be used on the LCD screen.

### 💡 Tip

- Your camcorder offers [ENG[SIMP]] (simplified English) in case that you cannot find your native tongue among the options.

## USB SELECT

You can connect the camcorder to a personal computer with a USB cable and view pictures on the “Memory Stick Duo” on the computer (p. 102). You can also connect the camcorder to a PictBridge compatible printer (p. 100) using this function.

### ▶ Memory Stick

Select to view pictures on a “Memory Stick Duo” on the computer or to export them to the computer.

### PictBridge PRINT

Select to connect your camcorder to a PictBridge compatible printer to print out directly (p. 100).

## PB ZOOM (Playback zoom)

When you set [PB ZOOM] to [ON], you can enlarge movie images about 1.1 to 5 times (still images about 1.5 to 5 times, the default setting is [OFF]). You can adjust the magnification with the zoom lever. To end the zoom, press the W side of the zoom lever.

### 💡 Tip

- To move the zoom horizontally, press the SEL/PUSH EXEC dial, then turn the dial. To move the zoom vertically, press the SEL/PUSH EXEC dial one more time, then turn the dial.

## QUICK REC

You can slightly reduce the recording start point time when resuming recording by turning the POWER switch from OFF (CHG) to CAMERA.

**► OFF**

It takes some time to restart recording from the state that the drum has stopped rotating, but the transition from the last recorded scene is smooth.

**ON (Q.REC)**

The time shortens slightly until recording restarts from the state that the drum has stopped rotating, but the transition from the last recorded scene may not be smooth. Select this when you do not want to miss a recording chance.

**💡 Tips**

- If [QUICK REC] is set to [ON], the interval between scenes freezes for a moment (editing on your computer is recommended).
- When the camcorder is left in standby for more than about 3 minutes, your camcorder exits from standby (the drum stops rotating) to prevent tape wear and battery loss. Since the power does not turn off, you can restart recording by pressing the REC START/STOP button again.

**DATE REC****► OFF**

Select not to superimpose the date and time on the pictures.

**ON**

Select to superimpose the date and time on the pictures.

**💡 Tips**

- When [DV WIDE REC] is set to [OFF], the date and time are displayed outside the 4:3 area but properly recorded on images.
- When you record in the HDV format, the date and time are displayed at different positions during recording and playback.

**BEEP****► ON**

Activates a melody when you start/stop recording.

**OFF**

Cancels the melody.

**REC LAMP (Recording lamp)**

The camera recording lamp will not light up during recording when you set this to [OFF] (the default setting is [ON]).

**REMOTE CTRL (Remote control)**

The default setting is [ON], allowing you to use the supplied Remote Commander (p. 143).

**💡 Tip**

- Set to [OFF] to prevent your camcorder from responding to a command sent by another VCR remote control unit.

**HOURS METER**

You can display the cumulative operation time of your camcorder with the total hours of operation, drum rotation, tape running, or the total number of tape unthreading operations.

**OPERATION**

Select to display the total hours of operation in 10-hour increments.

**DRUM RUN**

Select to display the total hours of drum rotation in 10-hour increments.

**TAPE RUN**

Select to display the total hours of tape running in 10-hour increments.

**THREADING**

Select to display the total number of tape unthreading operation in 10-operation increments.

# Dubbing to VCR, DVD/HDD device, etc.

Connect your camcorder to the wall socket using the supplied AC Adaptor for this operation (p. 22). Refer also to the instruction manuals supplied with the devices to be connected.

## Connecting to external devices

The connection method and the image quality will differ depending on the VCR, DVD/HDD device and the connectors used.

 : Signal flow

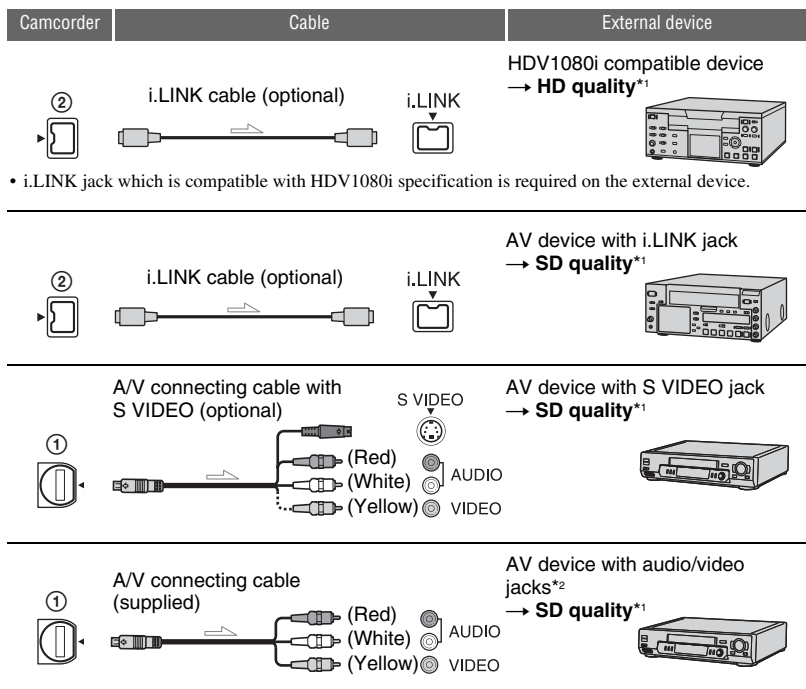

\*1 Pictures recorded in the DVCAM (DV) format are dubbed in the SD (standard definition) quality, regardless of the connection.

\*2 When connecting your camcorder to a monaural device, connect the yellow plug of the A/V connecting cable to the video jack on the device, and connect the white (left channel) or red (right channel) plug to the audio jack on the device.

### Note

- You cannot dub pictures using the HDMI cable.

## Jacks on your camcorder

Open the jack cover and connect the cable.

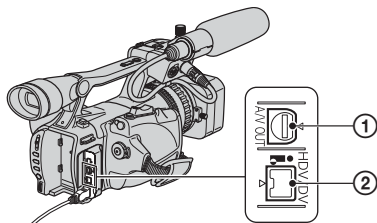

## Using an i.LINK cable (optional)

The dubbed format (HDV/DV) differs depending on the recording format or the format supported by the VCR/DVD device. See the table below for selecting the appropriate settings, and perform necessary menu setting.

### Note

- Disconnect the i.LINK cable before changing these menu settings, otherwise the VCR/DVD device may not correctly identify the video signal.

### Tip

- This camcorder has a 4-pin i.LINK terminal. Select a cable that fits the terminal on the device to be connected.

## Dubbing to VCR, DVD/HDD device, etc. (Continued)

Copy format	Camcorder recording format	Format supported by the VCR/DVD device		Menu setting	
		HDV format* <sup>1</sup>	DVCAM (DV) format	[VCR HDV/DV] (p. 82)	[i.LINK CONV] (p. 84)
Copy HDV recording as HDV	HDV	HDV	—* <sup>3</sup>		[OFF]
Convert HDV recording to DVCAM (DV)	HDV	DVCAM (DV)	DVCAM (DV)	[AUTO]	[ON]
Copy DVCAM (DV) recording as DVCAM (DV)	DVCAM (DV)	DVCAM (DV)	DVCAM (DV)		[OFF]
When tape is recorded in both HDV and DVCAM (DV) format					
Convert both HDV and DVCAM (DV) format to DVCAM (DV)	HDV/DVCAM (DV)	DVCAM (DV)	DVCAM (DV)	[AUTO]	[ON]
Copy only portions recorded in HDV format	HDV	HDV	—* <sup>3</sup>		
	DVCAM (DV)	—* <sup>2</sup>	—* <sup>3</sup>	[HDV]	[OFF]
Copy only portions recorded in DVCAM (DV) format	HDV	—* <sup>2</sup>	—* <sup>2</sup>		
	DVCAM (DV)	DVCAM (DV)	DVCAM (DV)	[DV]	[OFF]

\*<sup>1</sup> Recording device compliant with the HDV1080i specification.

\*<sup>2</sup> The tape advances, but no video or sound is recorded (blank).

\*<sup>3</sup> Picture is not recognized (no recording is made).

### 🔊 Notes

- When [VCR HDV/DV] is set to [AUTO], and the signal switches between HDV and DVCAM (DV) formats, the picture and sound are interrupted temporarily.
- When the recorder is HVR-V1E/V1P, set [VCR HDV/DV] to [AUTO] (p. 82).
- When the player and the recorder are both HDV1080i compatible devices such as HVR-V1E/V1P and connected with the i.LINK cable, after pausing or stopping and then resuming the recording, the images will be a bit choppy or rough at that point.
- Set [DISP OUTPUT] to [LCD PANEL] (the default setting) when connecting with an A/V connecting cable (p. 81).

### When connecting with the A/V connecting cable with S VIDEO (optional)

Connect with S VIDEO jack instead of the video plug (yellow). This connection produces pictures more faithfully. This connection produces higher quality DVCAM (DV) format pictures. The audio will not be output when you connect with the S VIDEO cable alone.

## Dubbing to another device

### 1 Prepare your camcorder for playback.

Insert the recorded cassette.  
Slide the POWER switch to VCR.

Set [DOWN CONVERT] according to the playback device (TV, etc.) (p. 84).

### 2 Prepare your VCR/DVD device for recording.

When dubbing to the VCR, insert a cassette for recording.  
When dubbing to the DVD recorder, insert a DVD for recording.

If your recording device has an input selector, set it to the appropriate input (such as video input1 and video input2).

### 3 Connect your VCR/DVD device to your camcorder as a recording device.



See page 92 for connection details.

### 4 Start playback on the camcorder, and recording on the VCR/DVD device.



Refer to the operating instructions supplied with your recording device for details.

### 5 When dubbing is complete, stop your camcorder and the VCR/DVD device.

## Notes

- The following cannot be output via the  HDV/DV interface (i.LINK):
  - Indicators
  - Titles that are recorded on other camcorder
- Pictures recorded in the HDV format are not output from the  HDV/DV interface (i.LINK) jack during playback pause or in any playback mode other than normal playback.
- Note the following when connecting with an i.LINK cable:
  - The recorded picture becomes rough when a picture is paused on your camcorder while recording to a VCR/DVD device.
  - Data codes (date/time/camera settings data) may not be displayed or recorded depending on the device or application.
  - You cannot record the picture and sound separately.
- When dubbing to a DVD recorder from your camcorder through an i.LINK cable, you may not operate your camcorder on your DVD recorder even if its instruction manual says you can. If you can set the input mode to HDV or DV on your DVD recorder and can input/output pictures, follow the steps in "Dubbing to another device."

## Tips

- To record the date/time and camera settings data when connected by the A/V connecting cable, display them on the screen.
- When you use an i.LINK cable, the video and sound signals are transmitted digitally, producing high quality pictures.
- When an i.LINK cable is connected, the format of the output signal (**HDVout**  or **DVOUT**  ) will be indicated on the LCD screen of your camcorder.

# Recording pictures from a VCR i.LINK

You can record pictures from a VCR on a tape. You can record a scene as a still image on a "Memory Stick Duo." You can record pictures in the HDV format by connecting an HDV1080i specification compatible device. Be sure to insert a cassette or a "Memory Stick Duo" for recording in your camcorder beforehand.

You can connect your camcorder to a VCR device using an i.LINK cable.

Connect your camcorder to the wall socket using the supplied AC Adaptor for this operation (p. 22). Refer also to the instruction manuals supplied with the devices to be connected.

## Notes

- You need an i.LINK cable for this operation.
- You cannot perform this operation with the A/V connecting cable.
- Your camcorder has a 4-pin i.LINK terminal. Select a cable that fits the terminal on the device to be attached.
- Your camcorder can only record from a PAL source. For example, French video or TV programs (SECAM) cannot be recorded correctly. See page 120 for details on TV color systems.
- If you use a 21-pin adaptor to input PAL source, you need a dual direction 21-pin adaptor (optional).

HDV1080i compatible device

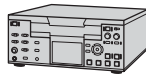

→ HD quality

AV device with i.LINK jack

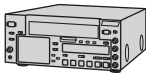

→ SD quality

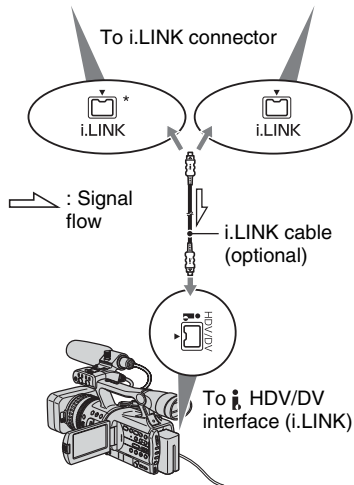

\* An i.LINK jack which is compatible with HDV1080i specification is required.

## Recording movies

**1** Set the POWER switch to VCR.

**2** Set the input signal of your camcorder.

Set [VCR HDV/DV] to [AUTO] when recording from an HDV format compatible device.

Set [VCR HDV/DV] to [DV] or [AUTO] when recording from a DVCAM (DV) format compatible device (p. 82).



### 3 Connect your VCR as a player to your camcorder.

When an i.LINK cable is connected, the format of the input signal (**HDVIN** **i.LINK** or **DVIN** **i.LINK**) will be indicated on the LCD screen of your camcorder (This indicator may appear on the screen of the playback device, however, it will not be recorded).

### 4 Insert a cassette into the VCR.

### 5 Set your camcorder to recording pause.

While pressing **II** (PAUSE), press both **●** REC (record) buttons simultaneously.

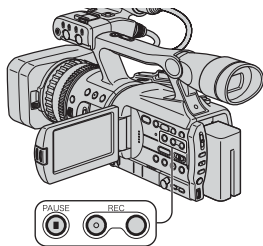

### 6 Start playing the cassette on your VCR.

The picture played on the VCR appears on the LCD screen of your camcorder.

### 7 Press **II** (PAUSE) again at the point you want to start recording.

### 8 Press **■** (STOP) to stop recording.

### Notes

- You cannot record TV programs from the **i** HDV/DV interface (i.LINK).
- User bits are not recorded when dubbing from a DVCAM (DV) device via an i.LINK cable.
- You can record pictures from DV devices only in the DVCAM (DV) format.
- Note the following when connecting with an i.LINK cable:
  - The recorded picture becomes rough when a picture is paused on your camcorder while recording to a VCR.
  - You cannot record the picture and sound separately.
  - If you pause or stop the recording and restart it, the picture may not be recorded smoothly.

### Tip

- When a 4:3 video signal is input, it appears with black bands on the right and left sides on the screen of your camcorder.

## Recording still images

Be sure to insert a “Memory Stick Duo” for recording in your camcorder beforehand, and set [PHOTO/EXP.FOCUS] to [PHOTO] (the default setting) (p. 90).

### 1 Perform steps 1 to 4 in “Recording movies.”



### 2 Start playing the cassette.

The pictures on the VCR appear on the screen of your camcorder.

### 3 Press the PHOTO/EXPANDED FOCUS button at the scene you want to record.

## Recording pictures from a VCR (Continued)

### Note

- Movies will be fixed to image size [ 1.2M] when playing back in the HDV format. Movies will be fixed to image size [ 0.2M] (16:9) or [VGA (0.3M)] (4:3) when playing back in the DVCAM (DV) format.

## Copying movies from tape to “Memory Stick Duo” as still images

You can record still images on a “Memory Stick Duo.” Be sure to insert a recorded tape and a “Memory Stick Duo” in your camcorder, and set [PHOTO/EXP.FOCUS] to [PHOTO] (the default setting) (p. 90) beforehand.

---

### **1** Set the POWER switch to the VCR.



---

### **2** Search and record the scene you want to record.

Press  (play) to play back the tape, then press the PHOTO/EXPANDED FOCUS button at the scene you want to record.

---

### Notes

- The date and time at which the picture was recorded on the tape and the date and time at which the picture was stored on the “Memory Stick Duo” are recorded. On your camcorder, the date and time at which the picture was recorded on the tape are displayed. Camera setting data recorded on the tape cannot be stored on the “Memory Stick Duo.”
- Movies will be fixed to image size [ 1.2M] when playing back in the HDV format. Movies will be fixed to image size [ 0.2M] (16:9) or [VGA (0.3M)] (4:3) when playing back in the DVCAM (DV) format.
- You cannot record still images while using [PB ZOOM] (p. 90).

# Deleting recorded pictures from the “Memory Stick Duo”

---

**1** Set the POWER switch to VCR.

---

**2** Playback a picture you want to delete (p. 36).

---

**3** Press the MEMORY/DELETE button.

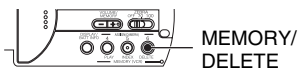

[Delete this image?] will be displayed.

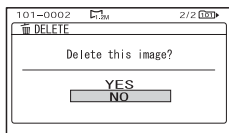

---

**4** Select [YES] by turning the SEL/PUSH EXEC dial, then press the dial.

The picture is deleted.

**Note**

- The pictures cannot be restored once they are deleted.

---

**Note**

- Pictures cannot be deleted when a “Memory Stick Duo” with the write-protect tab is set to the write-protect position (p. 125), or when the selected picture is protected (p. 110).

**Tips**

- To delete images from the index screen, use the VOLUME/MEMORY button to move the ► mark to the images you want to and perform steps 3 and 4.
- To delete all pictures at once, select [ALL ERASE] (p. 87).



# Printing recorded images (PictBridge compliant printer)

You can print out pictures using a PictBridge compliant printer without connecting the camcorder to a computer.

## PictBridge

Connect the AC Adaptor to your camcorder to obtain power from the wall socket. Insert the “Memory Stick Duo”, containing still images into your camcorder and turn on the printer.

### Connecting your camcorder to the printer

- 1 Set the POWER switch to VCR.
- 2 Press the MENU button, and select  (OTHERS) menu → [USB SELECT] → [PictBridge PRINT] with the SEL/PUSH EXEC dial.
- 3 Connect the USB cable to the  (USB) jacks of your camcorder and the printer.

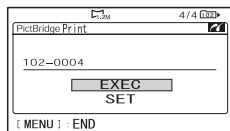
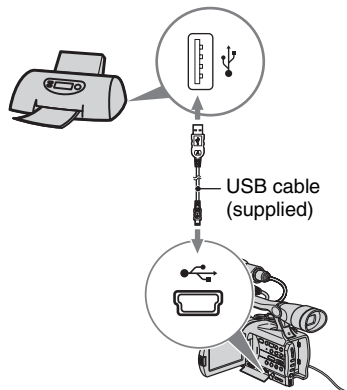

One of the images stored on the “Memory Stick Duo” will be displayed.

### Printing

- 1 Select the image you want to print with the VOLUME/MEMORY button.
- 2 Set the number of copies you want to print if necessary.

If you do not want to set the number, go to step 3 (the number will be automatically set to 1).

- ① Select [SET] → [COPIES] with the SEL/PUSH EXEC dial.
- ② Select the number by turning the SEL/PUSH EXEC dial, then press the dial.
- ③ Select [  RETURN ] by turning the SEL/PUSH EXEC dial, then press the dial.

The PictBridge selection screen appears again.

#### Tip

- You can set the number up to 20.

- 3 To print the date/time on the image, set as follows.

If you do not want to print the date/time, go to step 4.

- ① Select [SET] → [DATE/TIME] → [DATE] or [DAY & TIME] with the SEL/PUSH EXEC dial.
- ② Select [↩ RETURN] by turning the SEL/PUSH EXEC dial, then press the dial.

The PictBridge selection screen appears again.

---

## 4 Select [EXEC] → [YES] with the SEL/PUSH EXEC dial.

When printing is finished, [Printing...] disappears and the image selection screen appears again.

Press the MENU button when printing is completed.

---

### Notes

- We do not guarantee proper operation when a PictBridge incompatible device is connected.
- Refer also to the operating instructions for the printer to be used.
- Do not attempt the following operations when the printer is connected ( is on the screen). The operations may not be performed properly.
  - Operate the POWER switch.
  - Disconnect the USB cable from the printer.
  - Remove the “Memory Stick Duo” from your camcorder.
- If the printer stops working, disconnect the USB cable, turn the printer off and on again and restart the operation from the beginning.
- Depending on your printer, the top, bottom or side edges may be cut. Particularly when printing a wide (16:9) image, the sides may be cut significantly.
- Some printer models may not support the date/time printing function. Refer to your printer’s operating instructions for details.
- We cannot guarantee the printing of images recorded with a device other than your camcorder.

### Tip

- PictBridge is an industry standard established by the Camera & Imaging Products Association (CIPA). You can print still images without using a computer by connecting a printer directly to a digital video camera or digital still camera, regardless of model or manufacturer.

## Connecting to a computer

When connecting your camcorder to a computer, the following operations are available:

Copying the still images on a “Memory Stick Duo” to the computer

→ p. 102

Copying the movie on a tape in the HDV format to the computer

→ p. 105

Copying the movie on a tape in the DVCAM (DV) format to the computer

→ p. 105

### About connection

There are 2 ways to connect your camcorder to a computer:

– USB cable

To copy still images on a “Memory Stick Duo”

– i.LINK cable

To copy movies on a tape

### Notes on connecting to a computer

- When you are using a USB cable or an i.LINK cable to connect your camcorder to a computer, make sure to connect the connector in the correct direction. If you insert the connector forcibly, it may be damaged, and cause a malfunction of your camcorder.
- You cannot do the following:
  - Copying pictures on a tape to a computer with a USB cable.
  - Copying pictures on a “Memory Stick Duo” to a computer with an i.LINK cable.
- Remove the USB cable according to the correct procedure when disconnecting it from the computer (p. 104).

## Copying still images to a computer

### System requirements

#### For Windows users

- OS: Windows 2000 Professional/Windows Millennium Edition/Windows XP Home Edition/Windows XP Professional/Windows Vista\*
  - \* Except for 64-bit version
- It is necessary that your OS is factory-installed. Operations are not guaranteed if your OS has been upgraded or is being used in a multi-boot environment.
- CPU: MMX Pentium 200MHz or faster
- Others: USB port (provided as standard).

#### For Macintosh users

- OS: Mac OS 9.1/9.2 or Mac OS X (v10.1/v10.2/v10.3/v10.4)
- Others: USB port (provided as standard).

### Step:1 Using the USB cable

- You can do this operation with the standard driver on your computer. You do not need to install any software.
- If your computer has a Memory Stick slot, insert the “Memory Stick Duo” on which pictures are recorded into the Memory Stick Duo adaptor (optional), then insert it into the Memory Stick slot on your computer to copy still images to the computer.
- When using a “Memory Stick PRO Duo” and your computer is not compatible with it, connect your camcorder with the USB cable instead of using the Memory Stick slot on the computer.

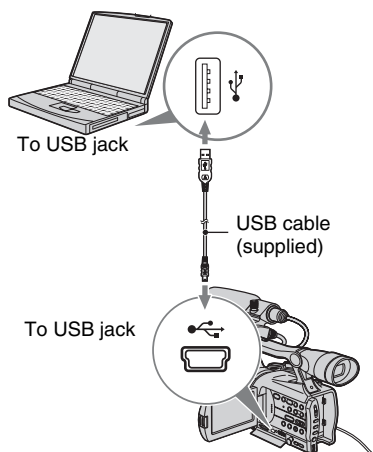

- Do not connect your camcorder to the computer at this point.
- The computer may not recognize the camcorder if you connect them with the USB cable before turning on your camcorder.
- See page 105 for the recommended connection.

## 1 Turn on the computer.

Close down all applications running on the computer.

### For Windows 2000/Windows XP/Windows Vista

Log on as an Administrator.

## 2 Insert a “Memory Stick Duo” into your camcorder.

## 3 Prepare the power source for your camcorder.

Use the supplied AC Adaptor to obtain AC power (p. 22).

## 4 Set the POWER switch to VCR.

## 5 Press the MENU button. The menu index screen is displayed.

## 6 Select [OTHERS] → [USB SELECT] → [Memory Stick] with the SEL/PUSH EXEC dial (p. 90).

## 7 Connect the USB cable to the (USB) jacks on your camcorder and your computer.

It may take a while until your computer recognizes your camcorder for the first time.

## Step:2 Copying the pictures

### For Windows users

Double-click the [Removable Disk] icon displayed in [My Computer]. Then, drag and drop a picture in the folder onto the hard disk drive of your computer.

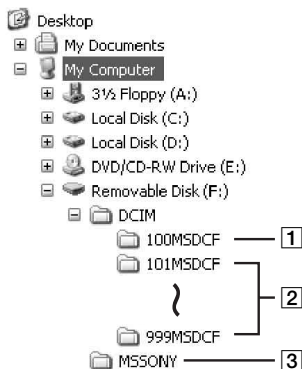

## Copying still images to a computer (Continued)

- 1 Folder containing image files recorded by other camcorders without the folder creation function (for playback only).
- 2 Folder containing image files recorded by your camcorder when no new folders have been created, only [101MSDCF] is displayed.
- 3 Folder containing movie data recorded by other camcorders without the folder creation function (for playback only)

Folder	File	Meaning
101MSDCF (up to 999MSDCF)	DSC0□□ □□.JPG file	Still image

□□□□ are numbers between 0001 and 9999.

### For Macintosh users

Double-click the drive icon, then drag and drop the desired picture file onto the hard disk of your computer.

## Disconnecting the USB cable

### For Windows users

If [USB CONNECTING] appears on the LCD screen, follow the procedure below to disconnect the USB cable.

- 1 Click the [Unplug or eject hardware] icon on the task tray.

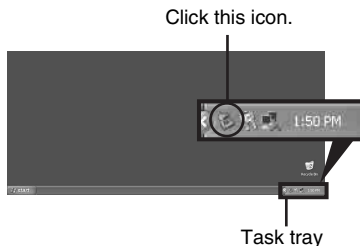

- 2 Click [Safely remove USB Mass Storage Device-Drive].



- 3 Click [OK].
- 4 Disconnect the USB cable from the camcorder and computer.

If [USB CONNECTING] does not appear on the LCD screen, do only step 4.

### Note

- Remove the USB cable according to the correct procedure, otherwise files in the "Memory Stick Duo" may not be updated correctly. Also, this may cause a malfunction of the "Memory Stick Duo."

### For Macintosh users

- 1 Close down all applications running on the computer.
- 2 Drag and drop the drive icon on the desktop onto the [Trash] icon.
- 3 Disconnect the USB cable from the camcorder and computer.



# Copying movies on a tape to a computer

## Notes

- If you are using Mac OS X, turn off the computer before disconnecting the USB cable and ejecting the “Memory Stick Duo.”
- Do not disconnect the USB cable while the access lamp is lit.
- Make sure to disconnect the USB cable before turning off your camcorder.

## Recommended connection

Observe the following points when connecting to ensure the camcorder operates correctly.

- Connect the camcorder to a computer via the USB cable. Make sure no other USB devices are connected to the computer.
- If your computer has a USB keyboard and a USB mouse as standard equipment, leave them connected and connect the camcorder to an available USB jack with the USB cable.
- Operation is not guaranteed if you connect two or more USB devices to the computer.
- Operation is not guaranteed if you connect the USB cable to the USB jack on a keyboard or USB hub.
- Make sure to connect the cable to the USB jack on the computer.
- Operation is not guaranteed even for the recommended environments.

Connect your camcorder to the computer with an i.LINK cable.

The computer needs to have an i.LINK connector and be installed with editing software that can copy video signals. The software required depends on the format of the recorded pictures and the format for copying to the computer (HDV or DVCAM (DV)) as shown in the table below.

Recorded format	Format for copying to the computer	Required software
HDV	HDV	Editing software capable of copying HDV signal
HDV	DVCAM (DV)	Editing software capable of copying DVCAM (DV) signal
DVCAM (DV)	DVCAM (DV)	Editing software capable of copying DVCAM (DV) signal

## Notes

- You cannot copy movies using a USB cable.
- Refer to the operating instructions of the software for the details on image copying.
- Refer to the operating instructions of the editing software for the recommended connection.
- Some editing software on the computer may not work correctly.
- You cannot change format DVCAM (DV) to HDV.

The required menu settings vary depending on the recorded images and the format (HDV or DVCAM (DV)) to be copied to the computer.

Recorded format	Format for copying to the computer	Menu setting*
HDV	HDV	[VCR HDV/DV] → [HDV] [i.LINK CONV] → [OFF]

## Copying movies on a tape to a computer (Continued)

Recorded format	Format for copying to the computer	Menu setting*
HDV	DVCAM (DV)	[VCR HDV/DV] → [HDV] [i.LINK CONV] → [ON]
		[VCR HDV/DV] → [DV] [i.LINK CONV] → [OFF]
DVCAM (DV)	DVCAM (DV)	[VCR HDV/DV] → [DV] [i.LINK CONV] → [OFF]

\* See page 64 for menu settings.

### Tips

- To copy HDV format images as they are without changing their format, an HDV compatible environment is required. For details, refer to your software instruction manual or contact the software manufacturer.
- To play movies by a regular DVD player, you need to create DVD video in the SD format. the DVD video is not in the HDV format.

### Step:1 Connect an i.LINK cable

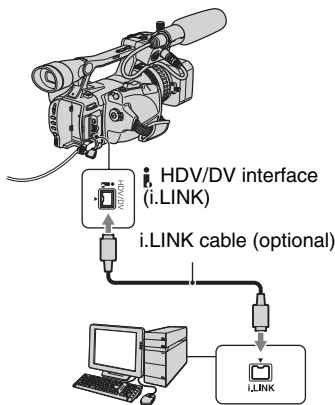

### Notes on connecting to the computer

- Connect the i.LINK cable to the computer first, then to your camcorder. Connecting in the opposite order may cause static electricity to build up, resulting in a malfunction of your camcorder.
- The computer may freeze or may not recognize the signal from your camcorder in the following situations.
  - Connecting your camcorder to a computer that does not support the video signal formats appearing on the LCD screen of your camcorder display (HDV or DVCAM (DV)).
  - Changing [VCR HDV/DV] (p. 82) and [i.LINK CONV] (p. 84) settings while connected with an i.LINK cable.
  - Changing [REC FORMAT] setting while connected with an i.LINK cable with the POWER switch set to CAMERA (p. 82).
  - Changing the POWER switch position while connected with an i.LINK cable.
- The format (HDV or DVCAM (DV)) of input/output signal appears on the LCD screen of your camcorder while connected with an i.LINK cable.

### Step:2 Copying the movies

Use the supplied AC Adaptor to obtain AC power (p. 22).

- Prepare editing software (not provided).
- Turn on your computer.
- Insert a tape into your camcorder and set the POWER switch to VCR.
- Set the menu of your camcorder. The menu settings vary depending on the copying image.
- Copy images to the computer with your software.

### Notes

- If images are copied in HDV format but not recognized, your editing software may not support HDV format. Convert the images to DVCAM (DV) format according to step 4 and copy again.
- A tape recorded in DVCAM (DV) format cannot be copied to a computer in HDV format.

### Tip

- When images recorded in HDV format are copied to a computer, the file size is about 2GB (almost the same as a DV file) for a 10-minute movie if the video compression format is MPEG2.

### **When copying the movie in the HDV format from the computer to your camcorder**

Set [VCR HDV/DV] to [HDV] and [i.LINK CONV] to [OFF] (p. 82, 84).

### Note

- To copy an HDV format movie edited on a computer back onto a tape in HDV format is possible so long as your editing software supports copying HDV movies onto tape. For details, contact the software manufacturer.

### **When copying the movie in the DVCAM (DV) format from the computer to your camcorder**

Set [VCR HDV/DV] to [DV] (p. 82).

# Troubleshooting

If you run into any problems using your camcorder, use the following table to troubleshoot the problem. If the problem persists, disconnect the power source and contact your Sony dealer.

- Power sources/LCD screen/Remote Commander...p. 108
- Cassette tapes/"Memory Stick Duo"...p. 109
- Recording...p. 110
- Playback...p. 112
- Connecting to TV...p. 114
- Dubbing/Editing/Connecting to other devices...p. 115
- Connecting to a computer...p. 116

## Power sources/LCD screen/Remote Commander

### The power does not turn on or abruptly turns off.

- Attach a charged battery pack to the camcorder (p. 22).
- Use the AC Adaptor to connect to a wall socket (p. 22).

---

### The camcorder does not operate even when the power is set to on.

- Disconnect the AC Adaptor from the wall socket or remove the battery pack, then reconnect it after about 1 minute.
- Press the RESET button (p. 141) using a sharp-pointed object.

---

### The camcorder gets warm.

- The camcorder may get warmer while you use it. This is not a malfunction.

---

### The CHARGE lamp does not light while the battery pack is being charged.

- Slide the POWER switch to OFF (CHG) (p. 22).
- Attach the battery pack to the camcorder correctly (p. 22).
- Connect the mains lead to the wall socket properly.
- The battery charge is completed (p. 22).

---

### The CHARGE lamp flashes while the battery pack is being charged.

- Attach the battery pack to the camcorder correctly (p. 22). If the problem persists, disconnect the AC Adaptor from the wall socket and contact your Sony dealer. The battery pack may be damaged.

---

### The remaining battery time indicator does not indicate the correct time.

- Ambient temperature is too high or too low, or the battery pack has not been charged enough. This is not a malfunction.
- Fully charge the battery again. If the problem persists, the battery may be worn-out. Replace it with a new one (p. 22, 127).
- The indicated time may not be correct in certain circumstances. For example, when you open or close the LCD panel, it takes about 1 minute to display the correct remaining battery time.

---

**The battery pack discharges too quickly.**

- Ambient temperature is too high or low, or the battery pack has not been charged enough. This is not a malfunction.
- Fully charge the battery again. If the problem persists, the battery may be worn-out. Replace it with a new one (p. 22, 127).

---

**The picture remains on the LCD screen.**

- This occurs if you disconnect the DC plug or remove the battery pack without turning off the power first. This is not a malfunction.

---

**The picture in the viewfinder is not clear.**

- Move the viewfinder lens adjustment lever until the picture appears clearly (p. 26).

---

**The picture in the viewfinder has disappeared.**

- If you change [VF POWERMODE] to [AUTO], the finder light remains off while the LCD panel is open (p. 80).

---

**The supplied Remote Commander does not function.**

- Set [REMOTE CTRL] to [ON] (p. 91).
- Remove any obstructions between the Remote Commander and the remote sensor.
- Keep strong light sources, such as sunlight or overhead lighting, away from the remote sensor, otherwise the Remote Commander may not function properly.
- Insert a fresh battery in the compartment with its +/- terminals matching those of the compartment (p. 143).

---

**Another VCR malfunctions when you use the supplied Remote Commander.**

- Select a commander mode other than VTR 2 for your VCR.
- Cover the sensor of your VCR with black paper.

---

**Cassette tapes/"Memory Stick Duo"****The cassette cannot be ejected from the compartment.**

- Make sure the power source (battery pack or AC Adaptor) is connected correctly (p. 22).
- Moisture condensation has occurred inside the camcorder (p. 130).

---

**The Cassette Memory indicator or title display does not appear while using a cassette with Cassette Memory.**

- This camcorder does not support Cassette Memory, so the indicator does not appear.

---

**The remaining tape indicator is not displayed.**

- Set [REMAINING] to [ON] to always display the remaining tape indicator (p. 81).

---

### The cassette is noisier during rewinding or fast-forwarding.

- When using the AC Adaptor, rewind/fast forward speed increases (compared with battery operation) and therefore increases noise. This is not a malfunction.

---

### You cannot delete pictures or format the “Memory Stick Duo.”

- Release the lock on the write-protect tab of the “Memory Stick Duo” if there is one (p. 125).
- The pictures are protected. Release the protect function on your computer, etc.

## Recording

---

### The recording does not start when you press the REC START/STOP button.

- Slide the POWER switch to CAMERA (p. 32).
- The tape has reached the end. Rewind it, or insert a new cassette.
- Set the write-protect tab of the cassette to REC or insert a new cassette (p. 121).
- The tape is stuck to the drum due to moisture condensation. Remove the cassette and leave your camcorder for at least 1 hour, then re-insert the cassette (p. 130).

---

### The handle zoom does not work.

- Set the handle zoom switch to H or L (p. 37).



---

### You cannot record on the “Memory Stick Duo.”

- Release the lock on the write-protect tab of the “Memory Stick Duo” if there is one (p. 125).
- The “Memory Stick Duo” is full. Delete unnecessary pictures recorded on the “Memory Stick Duo” (p. 99).
- Format the “Memory Stick Duo” on your camcorder (p. 88) or insert another “Memory Stick Duo” (p. 30).
- You cannot record still images on the “Memory Stick Duo” with:
  - While executing [FADER]
  - [SMTH SLW REC]
  - When the shutter speed is set to slower than 1/50
  - While checking/executing shot transition
  - When [PROG. SCAN] is set to [25]
- Set [PHOTO/EXP.FOCUS] to [PHOTO](p. 90).

---

### You cannot record a smooth transition on a tape from the last recorded scene to the next.

- Perform End search (p. 51).
- Do not remove the cassette (the picture will be recorded continuously without a break even when you turn the power off).
- Do not record pictures in the HDV and DVCAM (DV) formats on the same tape.
- Do not record pictures in DVCAM mode and DV SP mode on the same tape. 
- When [QUICK REC] is set to [ON], you cannot record a smooth transition (p. 90). 

---

### The shutter sound is not heard when you record a still image.

- Set [BEEP] to [ON] (p. 91).
  - There is no shutter sound while during movie shooting.
- 

### End search does not work.

- Do not eject the cassette after recording (p. 51).
  - There is nothing recorded on the cassette.
  - There is a blank section between recorded sections of the tape. This is not a malfunction.
- 

### Auto focus does not function.

- Press the FOCUS button to set to auto focus (p. 38).
  - If auto focus is difficult to use, focus manually (p. 38).
- 

### Menu items are grayed out or does not work.

- You cannot select gray out display items in the current recording/playback situation.
- There are some functions you cannot activate simultaneously. The following list shows examples of unworkable combinations of functions and menu items.

Cannot use	Situation
[BACK LIGHT]	During manual adjustment of [EXPOSURE1] or [EXPOSURE2]. Two or more of iris, gain, and shutter speed are set manually.
[SPOT LIGHT]	During manual adjustment of [EXPOSURE1] or [EXPOSURE2]. Two or more of iris, gain, and shutter speed are set manually.
[AE SHIFT]	During manual adjustment of [EXPOSURE1] or [EXPOSURE2]. Iris, gain, and shutter speed are all set manually.
[REC CTL MODE] under [EXT REC CTRL]	One of [SMTH SLW REC], [INTERVAL REC] and [DV FRAME REC] is set to [ON].
[CNTRST ENHCR]	During [BACK LIGHT].
[D.EXTENDER]	During [SMTH SLW REC]. [PROG. SCAN] is set to [25].
[SMTH SLW REC]	[COLOR BAR] is set to [ON]. [PROG. SCAN] is set to [25].
[INTERVAL REC]	[PROG. SCAN] is set to [25].
[HISTOGRAM]	During [DATE REC]. [COLOR BAR] is set to [ON].
[MARKER]	During [DATE REC].
[CAMERA PROF.]	During recording, playback, tape forwarding/rewinding.
[ALLSCAN MODE]	[DATE REC] is set to [ON].
[DATE REC]	[ALLSCAN MODE] is set to [ON].

### **Shutter speed, gain, white balance or iris cannot be adjusted manually.**

- Set the AUTO LOCK switch to the center position to release the auto lock mode.
- 

### **Tiny spots in white, red, blue, or green appear on the screen.**

- This phenomenon appears when using a slow shutter speed (p. 42). This is not a malfunction.
- 

### **The subjects passing by the frame very fast appear crooked.**

- This is called the focal plane phenomenon. This is not a malfunction. Because of the way that the image device (CMOS sensor) reads out image signals, the subjects passing by the frame rapidly might appear crooked depending on the recording conditions.
- 

### **The screen picture is bright, and the subject does not appear on the screen.**

- Cancel the BACK LIGHT function (p. 74).
- 

### **The screen picture is dark, and the subject does not appear on the screen.**

- Press and hold the DISPLAY/BATT INFO button for a few seconds to turn on the backlight (p. 26).
- 

### **Horizontal stripes appear on the image.**

- This occurs when recording pictures under a fluorescent lamp, sodium lamp, or mercury lamp. This is not a malfunction. This can be improved by changing the shutter speed (p. 42).
- 

### **Black bands appear when you record a TV screen or computer screen.**

- This can be improved by changing the shutter speed (p. 42).
- 

### **Fine patterns flicker, diagonal lines look jagged.**

- Adjust [SHARPNESS] to [0] side (p. 45).
- 

## Playback

If you are playing back pictures stored on a “Memory Stick Duo,” refer also to the Cassette tapes/“Memory Stick Duo” section (p. 109).

---

### **You cannot play back tape.**

- Slide the POWER switch to turn on the VCR.
- Rewind the tape (p. 35).



---

**Image data stored on a “Memory Stick Duo” cannot be played back correctly.**

- Image data cannot be played back if you have modified file names or folders, or have edited the data on a computer (In this case, the file name flashes). This is not a malfunction (p. 126).
- Pictures recorded on other devices may not be played back correctly. This is not a malfunction.

---

**The data file name is displayed incorrectly, or flashing.**

- The file is damaged.
- The file format is not supported on your camcorder (p. 125).
- Only the file name is displayed if the directory structure does not conform to the universal standard.

---

**Horizontal lines appear on the picture. The displayed pictures are not clear or do not appear.**

- Video head is dirty. Clean the head using the cleaning cassette (optional) (p. 131).

---

**You cannot hear the sound recorded with 4CH MIC REC on another camcorder.**

- Set [DV AUDIO MIX] (p. 77).

---

**No sound or only a low sound is heard.**

- Turn up the volume (p. 36).
- Set [DV AUDIO MIX] (p. 77).
- Pictures recorded using [SMTH SLW REC] do not have sounds.

---

**The picture or sound breaks off.**

- The tape was recorded in both of the HDV and DVCAM (DV) formats. This is not a malfunction.

---

**The movies freeze for a while, or the sound breaks off.**

- This occurs if the tape or video head is dirty (p. 131).
- Use the Sony mini DV cassette.

---

**“---” is displayed on the screen.**

- The tape you are playing was recorded without setting the date and time.
- A blank section on the tape is being played.
- The data code on a tape with a scratch or noise cannot be read.

---

**Noises appear and **NTSC** or **60i** is displayed on the screen.**

- The tape was recorded in a TV color system other than that of your camcorder (PAL). This is not a malfunction.

### Date Search does not work correctly.

- Be sure to record more than 2 minutes after the date changed. If one day's recording is too short, your camcorder may not accurately find the point where the recording date changes.
  - There is a blank section between recorded sections of the tape. This is not a malfunction.
- 

### No picture appears during End search, Rec review or Last scene review.

- The tape was recorded in both HDV and DVCAM (DV) formats. This is not a malfunction.
- 

### New sound added to a recorded tape on another camcorder is not heard.



- Adjust [DV AUDIO MIX] from [CH1,CH2] (original sound) side until the sound is heard appropriately (p. 77).
- 

### 4ch-12b appears on the LCD screen.

- This appears when you play back a tape recorded on other recording devices using a 4ch microphone (4CH MIC REC). This camcorder does not comply with the 4ch microphone recording standard.
- 

## Connecting to TV

### You cannot view the picture on the TV connected with the i.LINK cable.

- You cannot view the picture in the HD (high definition) quality on the TV if an i.LINK jack of the TV is not compatible with the HDV1080i specification (p. 58). Refer to the instruction manuals supplied with your TV.
  - Down convert the pictures recorded in HDV format and play back in DVCAM (DV) format (SD image quality) (p. 84).
  - Play back pictures using another connecting cable (p. 58).
- 

### You cannot hear the sound on the TV connected with the S VIDEO plug (S VIDEO channel) or component video plug.

- If you are using an S VIDEO plug or component video plug, make sure the red and white plugs of the A/V connecting cable are also connected (p. 58).
- 

### You cannot view the picture or hear the sound on the TV connected with the component video cable.

- Set [COMPONENT] according to the requirements of the connected device (p. 83).
  - When you are using the component video cable, make sure the red and white plugs of the A/V connecting cable are connected (p. 58).
- 

### You cannot view the picture or hear the sound on the TV connected with the HDMI cable.

- Pictures in the HDV format are not output from the HDMI OUT jack, if copyright protection signals are recorded in the pictures.

- DVCAM (DV) format pictures input to the camcorder via i.LINK cable (p. 96) cannot be output.
- This occurs if you record on a tape in both HDV and DVCAM (DV) formats. Disconnect and connect the HDMI cable, or slide the POWER switch to turn on your camcorder again.

---

**The picture appears distorted on the 4:3 TV.**

- This happens when viewing a picture recorded in the 16:9 (wide) mode on a 4:3 TV. Set [DOWN CONVERT] and play back the picture(p. 84).

---

**Black zone appears at top and bottom of a 4:3 TV screen.**

- This happens when viewing a picture recorded in the 16:9 (wide) mode on a 4:3 TV.
- This is not a malfunction.

## Dubbing/Editing/Connecting to other devices

---

**Pictures from connected devices cannot be zoomed.**

- You cannot zoom pictures from connected devices on your camcorder.

---

**Time code and other information appear on the display of the connected device.**

- Set [DISP OUTPUT] to [LCD PANEL] while connected with an A/V connecting cable (p. 81).

---

**You cannot dub correctly using the A/V connecting cable.**

- The A/V connecting cable is not connected properly.  
Make sure that the A/V connecting cable is connected to the input jack of the other device for dubbing a picture from your camcorder.

---

**When connected using an i.LINK cable, no picture appears on the monitor screen during dubbing.**

- Set [VCR HDV/DV] according to the requirements of the connected device (p. 82).

---

**You cannot add sound to the recorded tape.**

- You cannot add sound to the recorded tape on this unit.

---

**You cannot dub correctly using the HDMI cable.**

- You cannot dub pictures using the HDMI cable.

---

**Still pictures cannot be dubbed from a tape to a “Memory Stick Duo.”**

- You cannot capture pictures at all or good-quality pictures from the tape that has been used repeatedly for recording.

### When you copy a movie shot in wide (16:9) format using an i.LINK cable, the screen stretches vertically.

- You cannot output the aspect ratio setting using an i.LINK cable. Set the aspect ratio of the TV instead.
- Connect using an AV cable instead.

## Connecting to a computer



### The computer does not recognize your camcorder.

- Disconnect the cable from the computer and camcorder, then connect it again securely.
- Disconnect USB devices other than the keyboard, the mouse, and the camcorder from the  (USB) jack on the computer.
- Disconnect the cable from the computer and camcorder, restart the computer, then connect them again correctly.

### You cannot view or copy the video recorded on a tape on the computer.

- Disconnect the cable from the computer, then connect it again.
- Connect the i.LINK cable because you cannot copy video with the USB cable.

### You cannot view or copy still images recorded on a “Memory Stick Duo” on the computer screen.

- Insert a “Memory Stick Duo” in the correct direction, then push it all the way in.
- You cannot use an i.LINK cable. Connect the camcorder and the computer using the USB cable.
- Slide the POWER switch to turn on the VCR and set [USB SELECT] to  Memory Stick] (p. 90).
- The computer does not recognize the “Memory Stick Duo” during camcorder operations such as tape playback or editing. Finish any camcorder operations and then connect the camcorder to the computer again.
- Disconnect the USB device other than the keyboard, the mouse, and the camcorder from the  (USB) jack on the computer.

### Your computer freezes.

- Set [VCR HDV/DV] correctly according to the connected device (p. 82).
- Disconnect the cable from your computer and camcorder. Reboot your computer, and connect your computer and camcorder following the steps in the correct order (p. 106).

# Warning indicators and messages

## Self-diagnosis display/Warning indicators

If indicators appear on the LCD screen or in the viewfinder, check the following. Some symptoms you can fix by yourself. If the problem persists even after you have tried a couple of times, contact your Sony dealer or local authorized Sony service facility.

### C:(or E:) □□:□□ (Self-diagnosis display)

#### C:04:□□

- The battery pack is not an “InfoLITHIUM” battery pack. Use an “InfoLITHIUM” battery pack (p. 127).
- Connect the DC plug of the AC Adaptor to the DC IN jack of your camcorder securely (p. 22).

#### C:21:□□

- Moisture condensation has occurred. Remove the cassette and leave your camcorder for at least 1 hour, then re-insert the cassette (p. 130).

#### C:22:□□

- Clean the head using a cleaning cassette (optional) (p. 131).

#### C:31:□□ / C:32:□□

- Symptoms that are not described above have occurred. Remove and insert the cassette, then operate your camcorder again. Do not perform this procedure if moisture condensation has occurred (p. 130).
- Remove the power source. Reconnect it and operate your camcorder again.
- Change the cassette. Press the RESET button (p. 141), and operate your camcorder again.

#### E:61:□□ / E:62:□□

- Contact your Sony dealer or local authorized Sony service facility. Inform them of the 5-digit code, which starts from “E.”

### 101-1001(Warning indicator pertaining to files)

- The file is damaged.
- The file is unreadable (p. 126).

### (Battery level warning)

- The battery pack is nearly used up.
- Depending on the operating, environment, or battery conditions,  may flash, even if there are approximately 5 to 10 minutes remaining.

### (Moisture condensation warning)\*

- Eject the cassette, remove the power source, and then leave it for about 1 hour with the cassette lid open (p. 130).

### (Warning indicator pertaining to “Memory Stick Duo”)

- A “Memory Stick Duo” is not inserted (p. 30).

### (Warning indicators pertaining to “Memory Stick Duo” formatting)\*

- The “Memory Stick Duo” is damaged.
- The “Memory Stick Duo” is not formatted correctly (p. 88, 125).

### (Warning indicators pertaining to unsupported “Memory Stick Duo”)

- A “Memory Stick Duo” that cannot be used in your camcorder is inserted (p. 125).

### (Warning indicators pertaining to the tape)

#### Slow flashing:

- There is less than 5 minutes remaining on the tape.
- No cassette is inserted.\*
- The write-protect tab on the cassette is set to lock (p. 121).\*

### **Fast flashing:**

- The tape has run out.\*

---

### **▲ (Eject cassette warning)\***

#### **Slow flashing:**

- The write-protect tab on the cassette is set to lock (p. 121).

#### **Fast flashing:**

- Moisture condensation has occurred (p. 130).
- The self-diagnosis display code is displayed (p. 117).

---

### **☐ ○ (Warning indicator pertaining to the write-protect of the “Memory Stick Duo”)\***

- The write-protect tab on the “Memory Stick Duo” is set to lock (p. 125).

\* You hear a melody when the warning indicators appear on the screen (p. 117).

## Description of warning messages

If messages appear on the screen, follow the instructions.

### ■ **Battery/Power**

---

**Use the “InfoLITHIUM” battery pack**  
(p. 127)

### ■ **Moisture condensation**

---

**☐▲ Moisture condensation. Eject the cassette** (p. 130)

---

**☐ Moisture condensation. Turn off for 1H.** (p. 130)

### ■ **Cassette/Tape**

---

**▲ Reinsert the cassette.** (p. 30)

- Check if the cassette is damaged.

---

**☐▲ The tape is locked - check the tab.** (p. 121)

---

**Cannot record due to copyright protection.** (p. 121)

### ■ **“Memory Stick Duo”**

---

**☐ Incompatible type of Memory Stick.**

- A type of “Memory Stick Duo” incompatible with your camcorder is inserted (p. 125).

---

**Protected file. Cannot delete.**

- Cancel file protection using your computer.

---

**☐ Reinsert the Memory Stick.**  
(p. 30, 125)

- Reinsert the “Memory Stick Duo” a few times. If even then the indicator flashes, the “Memory Stick Duo” might be damaged. Try with another “Memory Stick Duo.”

---

**☐ This Memory Stick is not formatted correctly.**

- Check the format, then format the “Memory Stick Duo” as necessary (p. 88, 125).

---

**Memory Stick folders are full.**

- You cannot create folders exceeding 999MSDCF. You cannot delete created folders using your camcorder.
- You will have to format the “Memory Stick Duo” (p. 88), or delete them using your computer.

---

**Cannot record still images on Memory Stick.**

- You cannot record still images in the following cases:
  - When the shutter speed is 1/50 or less
  - While using [FADER]
  - While using [SMTH SLW REC]
  - While checking or executing shot transition
  - While [PROG. SCAN] is set to [25]

---

**■ PictBridge compliant printer**

---

**Check the connected device.**

- Switch off the printer and switch it on again, then disconnect the USB cable and reconnect it.

---

**Error. Cancel the task.**

- Switch off the printer and switch it on again, then disconnect the USB cable and reconnect it.

---

**■ Others**

---

**Change to correct tape format.**

- The pictures cannot be played back because of an incompatible format.

---

**No output image in “VCR HDV/DV”.  
Change format.**

- Stop playback or signal input, or change [VCR HDV/DV] setting (p. 82).

---

** Dirty video head. Use a cleaning cassette. (p. 131)**

---

**Could not synchronize TC.**

- Make sure that a tape is in the connected camcorder (p. 85).
-

# Using your camcorder abroad

## Power supply

You can use your camcorder in any country/region using the AC Adaptor supplied with your camcorder within the AC 100 V to 240 V, 50/60 Hz range. Use a commercially available AC plug adaptor [a], if necessary, depending on the design of the wall outlet [b].

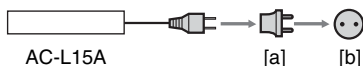

## On TV color systems

Your camcorder is PAL system, so its picture can only be viewed on a PAL system TV with an AUDIO/VIDEO input jack.

System	Used in
PAL	Australia, Austria, Belgium, China, Czech Republic, Denmark, Finland, Germany, Holland, Hong Kong, Hungary, Italy, Kuwait, Malaysia, New Zealand, Norway, Poland, Portugal, Singapore, Slovak Republic, Spain, Sweden, Switzerland, Thailand, United Kingdom, etc.
PAL - M	Brazil
PAL - N	Argentina, Paraguay, Uruguay.
SECAM	Bulgaria, France, Guiana, Iran, Iraq, Monaco, Russia, Ukraine, etc.
NTSC	Bahama Islands, Bolivia, Canada, Central America, Chile, Colombia, Ecuador, Guyana, Jamaica, Japan, Korea, Mexico, Peru, Surinam, Taiwan, the Philippines, the U.S.A., Venezuela, etc.

## Viewing HDV format pictures recorded in HDV format (HDV1080i)

You need an HDV1080i compatible TV (or monitor) with a component jack and AUDIO/VIDEO input jack. A component video cable and A/V connecting cable are also needed.

## Viewing DVCAM (DV) format pictures recorded in DVCAM (DV) format

**DVCAM DV**

You need a TV with the AUDIO/VIDEO input jack. A connecting cable is also needed.

## Simple setting of the clock by time difference

When you are abroad, you can easily adjust the clock to the local time by setting the time difference. Select [WORLD TIME], then set the time difference (p. 90).



# HDV format and recording/playback

Your camcorder is capable of recording in HDV/DVCAM/DV formats.

It is recommended to use a cassette with the  mark to record in the HDV/DVCAM/DV format.

It is recommended to use a cassette with the  mark to record in the DVCAM format.

Your camcorder is not compatible with the Cassette Memory function.

## What is the HDV format?

The HDV format is a video format developed to record and play back digital high definition (HD) video signals on a DV cassette.

Your camcorder adopts the Interlace mode with 1,080 effective scan lines of screen ruling (1080i, number of pixels 1,440 × 1,080 dots).

The video bit rate for recording is about 25 Mbps.

i.LINK is adopted for the digital interface, enabling a digital connection with an HDV compatible TV or computer.

- HDV signals are compressed in MPEG2 format, which is adopted in BS (broadcast satellite) digital, terrestrial digital HDTV broadcastings, in Blu-ray Disc recorders, etc.

## Playback

- Your camcorder can play back pictures in both the DVCAM (DV) format and HDV1080i specification.
- Your camcorder can play back pictures recorded in the HDV 720/30p format, but cannot output it from the  HDV/DV interface (i.LINK).

## To prevent a blank section from being created on the tape

Go to the end of the recorded section using [END SEARCH] (p. 51) before you begin the next recording when you have played back the tape.

## Copyright signal

### ■ When you play back

If the cassette you play back on your camcorder contains copyright signals, you cannot copy it to a tape in another video camera connected to your camcorder.

### ■ When you record

You cannot record software on your camcorder that contains copyright control signals for copyright protection of software. [Cannot record due to copyright protection.] appears on the LCD screen, or on the viewfinder if you try to record such software. Your camcorder does not record copyright control signals on the tape when it records.

## Audio mode

The DVCAM format has 2 audio modes.

- You cannot dub sound onto a recorded tape with your camcorder.

### ■ FS32K (12-bit) mode

The original sound is recorded in channels 1 and 2, and the new sound in channels 3 and 4. The balance between channels 1/2 and channels 3/4 can be adjusted by selecting [DV AUDIO MIX] in the menu settings during playback. If you select [MIX], the sounds of channel 1/2 and channel 3/4 are synthesized to be output.

### ■ FS48K (16-bit) mode

The original sound can be recorded in high quality using 2 channels. The audio mode can be indicated on the LCD screen or in the viewfinder.

## Notes on use

### ■ When not using your camcorder for a long time

Remove the cassette and store it.

### ■ To prevent accidental erasure

Slide the write-protect tab on the cassette to set it to SAVE.

## HDV format and recording/playback (Continued)

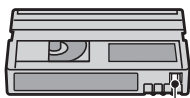

REC: The cassette can be recorded.

SAVE: The cassette cannot be recorded (write-protected).



### On Sony HDV1080i compliant TVs

HDV1080i

An HDV format compatible TV with the component input jack is required to view playback pictures recorded in the HDV format.

#### ■ When labeling the cassette

Be sure to place the label only on the locations shown in the following illustration so as not to cause a malfunction of your camcorder.

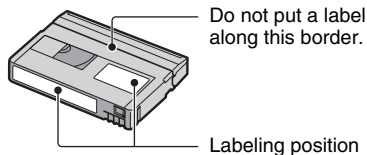

#### ■ After using the cassette

Rewind the tape to the beginning to avoid distortion of the picture or the sound. The cassette should then be put in its case, and stored in an upright position.

#### ■ When cleaning the gold-plated connector

Generally, clean the gold-plated connector on a cassette with a cotton-wool swab after every 10 times it has been ejected.

If the gold-plated connector on the cassette is dirty or dusty, the remaining tape indicator may not show correctly.

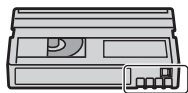

Gold-plated connector

# Compatibility of the DVCAM/DV formats

The DVCAM format was developed as a more reliable and higher-end format than the consumer DV format. Explained here are the differences, compatibility, and limitations on editing for the DVCAM and DV formats.

## Differences between the DVCAM and DV formats

Specification	DVCAM	DV
TRACK Pitch	15 $\mu\text{m}$	10 $\mu\text{m}$
Audio sampling frequency	12 bit:32 kHz 16 bit:48 kHz	12 bit:32 kHz 16 bit:48 kHz 44.1 kHz 48 kHz
Audio recording mode*	Lock mode	Lock/Unlock mode

\* There are 2 modes for audio recording, lock mode and unlock mode. In lock mode, the sampling frequencies of audio and video are synchronized. Therefore, lock mode is more effective than unlock mode in digital processing and smooth transition during audio editing.

## Mini DVCAM and mini DV cassettes

The recording format of the picture is defined according to the recorder's format as described below.

Recorder's format	Cassette's format	Recording format
DVCAM	DVCAM DV	DVCAM
DV	DVCAM DV	DV

### Notes

- This camcorder complies with the DVCAM format. Though mini DV cassettes can be used for recording, we recommend you use mini DVCAM cassettes to get the most out of the high reliability of the DVCAM format.
- The recording time of mini DV cassettes is 1/3 shorter than that indicated on mini DV cassettes when recorded in the DVCAM format.

## Compatibility on playback

Tape	On DV video equipment	On DVCAM video equipment
DV formatted	Can be playback	Can be played back only when recorded in SP mode
DVCAM formatted	Can be played back on some equipment	Can be playback

### Compatibility on editing using DV jacks

When this camcorder is connected to other digital video equipment using an i.LINK cable, the recording format of edited tapes is defined according to the source tape and the recorder's format as described below. Playback or editing using the edited tape may be limited depending on dubbing operation. Start dubbing after reading "Limitations on editing" (p. 115).

Source tape	Player's format	Recorder's format	Recording format
DV formatted (SP mode only)	DVCAM	DVCAM DV	DVCAM <sup>1)</sup> DV
DV formatted	DV	DVCAM DV	DVCAM DV
DVCAM formatted <sup>2)</sup>	DVCAM	DVCAM DV	DVCAM DV
DVCAM formatted <sup>2)</sup>	DV <sup>3)</sup>	DVCAM	DVCAM (Compatibility depends on models.)
		DV	DV

<sup>1)</sup> When using mini DVCAM video equipment to perform DV dubbing of a tape recorded in DV format, the tape produced will be in the DVCAM format which the time code format will be partly misadjusted. (there will be no effect on the recorded picture except in certain cases.)

<sup>2)</sup> If the tape that is to be dubbed is in the DVCAM format as in 1), the tape produced will be in the DVCAM format and the time code format will be partly misadjusted.

<sup>3)</sup> Some mini DV video equipment may be able to play back a DVCAM-formatted tape. Even if the tape is played back, quality of the playback cannot be guaranteed. The time code format will be partly misadjusted.

### Note

- If you use tapes as in 1) to 3) above for editing, the functions may be limited regardless of the format of players and recorders.

### Limitations on editing

You may find the following limitations when editing a tape produced by dubbing or editing using the HDV/DV Interface

 (i.LINK) jack:

- Due to the difference in track pitch, you cannot record or edit on DV-formatted tapes using mini DVCAM video equipment.
- Depending on the DVCAM video equipment used, you may not be able to edit DVCAM formatted tapes if the audio recording mode is unlock mode. In this case, dub using audio/video jacks.

# About the “Memory Stick”

A “Memory Stick” is a compact, portable IC recording medium with a large data capacity.

You can use only a “Memory Stick Duo,” which is about the half size of a standard “Memory Stick,” with your camcorder. However, we do not guarantee the operation of all types of “Memory Stick Duo” on your camcorder. (See the list below for more details.)

Types of “Memory Stick”	Recording/ Playback
“Memory Stick” (without MagicGate)	–
“Memory Stick Duo” <sup>*1</sup> (without MagicGate)	○
“MagicGate Memory Stick”	–
“Memory Stick Duo” <sup>*1</sup> (with MagicGate)	○ <sup>*2*3</sup>
“MagicGate Memory Stick Duo” <sup>*1</sup>	○ <sup>*3</sup>
“Memory Stick PRO”	–
“Memory Stick PRO Duo” <sup>*1</sup>	○ <sup>*2*3</sup>

<sup>\*1</sup> A “Memory Stick Duo” is about half the size of a standard “Memory Stick.”

<sup>\*2</sup> The types of “Memory Stick” that support high speed data transfer. The speed of data transfer varies depending on the device to be used.

<sup>\*3</sup> “MagicGate” is a copyright protection technology that records and transfers the contents in an encrypted format. Note that data that uses “MagicGate” technology cannot be recorded or played on your camcorder.

- Still image format: Your camcorder compresses and records image data in the JPEG (Joint Photographic Experts Group) format. The file extension is “.JPG.”
- File names of still images:
  - 101-0001: This file name appears on the screen of your camcorder.
  - DSC00001.JPG: This file name appears on the display of a computer.
- A “Memory Stick Duo” formatted by a computer (Windows OS/Mac OS) does not have guaranteed compatibility with your camcorder.

- Data read/write speed may vary depending on the combination of the “Memory Stick” and “Memory Stick” compliant product you use.
- This unit does not support high speed data transfer.

## On a “Memory Stick Duo” with a write-protect tab

You can prevent accidental erasure of images when you slide the write-protect tab on the “Memory Stick Duo” with a small tapered object, to the write-protect position.

## Notes on use

Damaged or lost image data will not be compensated for, and may occur in the following cases:

- If you eject the “Memory Stick Duo,” turn the power off on your camcorder, or remove the battery pack for replacement while your camcorder is reading or writing image files on the “Memory Stick Duo” (while the access lamp is lit or flashing).
- If you use the “Memory Stick Duo” near magnets or magnetic fields.

It is recommended you make a back-up of important data on the hard disk of a computer.

## ■ On handling a “Memory Stick”

Keep the following in mind when handling a “Memory Stick Duo.”

- Be careful not to apply excessive force when writing on a memo area on a “Memory Stick Duo.”
- Do not attach a label or the like on a “Memory Stick Duo” or a Memory Stick Duo adaptor.
- When you carry or store a “Memory Stick Duo,” put it in its case.
- Do not touch, or allow metallic objects to come into contact with the terminals.
- Do not bend, drop or apply strong force to the “Memory Stick Duo.”
- Do not disassemble or modify the “Memory Stick Duo.”
- Do not let the “Memory Stick Duo” get wet.

## About the “Memory Stick” (Continued)

- Be careful to keep “Memory Stick Duo” media out of the reach of small children. There is danger that a child might swallow it.
- Do not insert anything other than a “Memory Stick Duo” into the “Memory Stick Duo” slot. Doing so may cause a malfunction.

### ■ On a location for use

Do not use or keep the “Memory Stick Duo” in the following locations.

- Places subject to extremely high temperature, such as a car parked outside in the summer.
- Places under direct sunlight.
- Places with extremely high humidity or subject to corrosive gases.

### ■ On the Memory Stick Duo adaptor

After inserting a “Memory Stick Duo” into the Memory Stick Duo adaptor, you can use it with a standard “Memory Stick” compliant device.

- When using a “Memory Stick Duo” with a “Memory Stick” compliant device, be sure to insert the “Memory Stick Duo” into a Memory Stick Duo adaptor.
- When inserting a “Memory Stick Duo” into a Memory Stick Duo adaptor, make sure the “Memory Stick Duo” is inserted facing in the correct direction, then insert it all the way in. Note that improper use may cause a malfunction. Also, if you force the “Memory Stick Duo” into the Memory Stick Duo adaptor in the wrong direction, it may be damaged.
- Do not insert a Memory Stick Duo adaptor without a “Memory Stick Duo” attached. Doing so may result in malfunctions of the unit.



### ■ On a “Memory Stick PRO Duo”

- The maximum memory capacity of a “Memory Stick PRO Duo” that can be used on your camcorder is 4 GB.

## On image data compatibility

- Image data files recorded on a “Memory Stick Duo” by your camcorder conform to the “Design rule for Camera File system” universal standard established by the JEITA (Japan Electronics and Information Technology Industries Association).
- On your camcorder, you cannot play back still images recorded on other devices (DCR-TRV900 or DSC-D700/D770) that do not conform to the universal standard (these models are not sold in some regions).
- If you cannot use a “Memory Stick Duo” that has been used with another device, format it with your camcorder (p. 88). Note that formatting erases all information on the “Memory Stick Duo.”
- You may not be able to play back images with your camcorder:
  - When playing back image data modified on your computer.
  - When playing back image data recorded with other devices.

# About the “InfoLITHIUM” battery pack

This unit is compatible with an “InfoLITHIUM” battery pack (L series). Your camcorder operates only with an “InfoLITHIUM” battery pack. “InfoLITHIUM” L series battery packs have the  **InfoLITHIUM**  mark.

## What is an “InfoLITHIUM” battery pack?

An “InfoLITHIUM” battery pack is a lithium-ion battery pack that has functions for communicating information related to operating conditions between your camcorder and an optional AC Adaptor/charger.

The “InfoLITHIUM” battery pack calculates the power consumption according to the operating conditions of your camcorder, and displays the remaining battery time in minutes.

With an AC Adaptor/charger, the remaining battery time and charging time appear.

## To charge the battery pack

- Be sure to charge the battery pack before you start using your camcorder.
- We recommend charging the battery pack in an ambient temperature of between 10 °C to 30 °C (50 °F to 86 °F) until the CHARGE lamp turns off. If you charge the battery pack outside of this temperature range, you may not be able to charge it efficiently.
- After charging is complete, disconnect the cable from the DC IN jack on your camcorder or remove the battery pack.

## To use the battery pack effectively

- Battery pack performance decreases when the surrounding temperature is 10 °C (50 °F) or below, and the length of time you can use the battery pack becomes shorter. In that case, do one of the following to use the battery pack for a longer time.
  - Put the battery pack in a pocket to warm it up, and insert it in your camcorder right before you start taking shots.
  - Use a large capacity battery pack: NP-F770/F970 (optional).
- Frequent use of the LCD screen or a frequent playback, fast forward or rewind operation wears out the battery pack faster. We recommend using a large capacity battery pack: NP-F770/F970.
- Be sure to set the POWER switch to OFF (CHG) when not recording or playing back on your camcorder. The battery pack is also consumed when your camcorder is in recording standby or playback pause.
- Have spare battery packs ready for two or three times the expected recording time, and make trial recordings before making the actual recording.
- Do not expose the battery pack to water. The battery pack is not water resistant.

## About the remaining battery time indicator

- When the power goes off even though the remaining battery time indicator indicates that the battery pack has enough power to operate, charge the battery pack fully again. Remaining battery time will be indicated correctly. Note, however, that the battery indication will not be restored if it is used in high temperatures for a long time, or if left in a fully charged state, or when the battery pack is frequently used. Use the remaining battery time indication as a rough guide only.
- The  mark that indicates low battery flashes even if there are still 5 to 10 minutes of battery time remaining, depending on the operating conditions or ambient temperature.

## About the “InfoLITHIUM” battery pack (Continued)

### About storage of the battery pack

- If the battery pack is not used for a long time, fully charge the battery pack and use it up on your camcorder once a year to maintain proper function. To store the battery pack, remove it from your camcorder and put it in a dry, cool place.
- To discharge the battery pack on your camcorder completely, leave your camcorder in tape recording standby until the power goes off (p. 25).

### About battery life

- Battery capacity decreases over time and through repeated use. If decreased usage time between charges becomes significant, it is probably time to replace it with a new one.
- Each battery's life is governed by storage, operating and environmental conditions.

## About i.LINK

The HDV/DV interface on this unit is an i.LINK-compliant interface. This section describes the i.LINK standard and its features.

### What is i.LINK?

i.LINK is a digital serial interface for transferring digital video, digital audio, and other data to other i.LINK-compatible devices. You can also control other devices using the i.LINK.

i.LINK-compatible devices can be connected using an i.LINK cable. Possible applications are operations and data transactions with various digital AV devices.

When two or more i.LINK-compatible devices are daisy-chained with the unit, operation becomes possible from any device in the chain. Note that operation method may vary, or data transactions may not be possible, depending on specifications and characteristics of the connected devices.

### Notes

- Normally, only one device can be connected to this unit with an i.LINK cable. When connecting this unit to an HDV/DV compatible device having two or more  HDV/DV interfaces, refer to the operating instructions of the device to be connected.
- i.LINK is a more familiar term for the IEEE 1394 data transport bus proposed by Sony, and is a trademark approved by many corporations.
- IEEE 1394 is an international standard standardized by the Institute of Electrical and Electronics Engineers.



## About the i.LINK Baud rate

i.LINK's maximum baud rate varies according to the device. There are 3 types.

S100 (approx. 100Mbps\*)

S200 (approx. 200Mbps)

S400 (approx. 400Mbps)

The baud rate is listed under "Specifications" in the operating instructions of each piece of equipment. It is also indicated near the i.LINK interface on some devices.

The baud rate may differ from the indicated value when the unit is connected to a device with a different maximum baud rate.

### \* What is Mbps?

Mbps stands for "megabits per second," or the amount of data that can be sent or received in one second. For example, a baud rate of 100 Mbps means that 100 megabits of data can be sent in one second.

## To use i.LINK functions on this unit

For details on how to dub when this unit is connected to other video devices having an i.LINK interface, see page 95.

This unit can also be connected to other i.LINK-compatible devices made by Sony (for example, a VAIO series personal computer) as well as to video devices. Some i.LINK compatible video devices, such as Digital Televisions, DVD, MICROMV or HDV recorders/players are not compatible with this unit. Before connecting to other devices, be sure to confirm whether the device is compatible with an HDV/DV device or not. For details on precautions and compatible application software, refer also to the operating instructions for the device to be connected.

### Note

- When connecting a device with an i.LINK terminal to your camcorder via an i.LINK cable, switch off the device and unplug it from the power socket before plugging in or unplugging the i.LINK cable.

## About the required i.LINK cable

Use the Sony i.LINK 4-pin-to-4-pin cable (during HDV/DVCAM (DV) dubbing).

# Maintenance and precautions

## On use and care

- Do not use or store the camcorder and accessories in the following locations.
  - Anywhere extremely hot or cold. Never leave them exposed to temperatures above 60 °C (140 °F), such as under direct sunlight, near heaters or in a car parked in the sun. They may malfunction or become deformed.
  - Near strong magnetic fields or mechanical vibration. The camcorder may malfunction.
  - Near strong radio waves or radiation. The camcorder may not be able to record properly.
  - Near AM receivers and video equipment. Noise may occur.
  - On a sandy beach or anywhere dusty. If sand or dust gets in your camcorder, it may malfunction. Sometimes this malfunction cannot be repaired.
  - Near windows or outdoors, where the LCD screen, the viewfinder, or the lens may be exposed to direct sunlight. This damages the inside of the viewfinder or the LCD screen.
  - Anywhere very humid.
- Operate your camcorder on DC 7.2 V (battery pack) or DC 8.4 V (AC Adaptor).
- For DC or AC operation, use the accessories recommended in these operating instructions.
- Do not let your camcorder get wet, for example, from rain or sea water. If your camcorder gets wet, it may malfunction. Sometimes this malfunction cannot be repaired.
- If any solid object or liquid gets inside the casing, unplug your camcorder and have it checked by a Sony dealer before operating it any further.
- Avoid rough handling, disassembling, modifying, physical shock, or impact such as hammering, dropping or stepping on the product. Be particularly careful of the lens.
- Keep the POWER switch setting to OFF (CHG) when you are not using your camcorder.
- Do not wrap your camcorder with a towel, for example, and operate it. Doing so might cause heat to build up inside.
- When disconnecting the mains lead, pull it by the plug and not the lead.
- Do not damage the mains lead such as by placing anything heavy on it.
- Keep metal contacts clean.

- Keep the Remote Commander and button-type battery out of children's reach. If the battery is accidentally swallowed, consult a doctor immediately.
- If the battery electrolytic liquid has leaked,
  - consult your local authorized Sony service facility.
  - wash off any liquid that may have contacted your skin.
  - if any liquid gets in your eyes, wash with plenty of water and consult a doctor.

## ■ When not using your camcorder for a long time



- Periodically turn on the camcorder and play a cassette for about 3 minutes.
- Use up the battery pack completely before storing it.

## Moisture condensation

If your camcorder is brought directly from a cold place to a warm place, moisture may condense inside your camcorder, on the surface of the tape, or on the lens. In this state, the tape may stick to the head drum and be damaged or your camcorder may not operate correctly. If there is moisture inside your camcorder, [Moisture condensation. Eject the cassette] or [Moisture condensation. Turn off for 1H.] appears. The indicator will not appear when the moisture condenses on the lens.

### ■ If moisture condensation has occurred

None of the functions except cassette ejection will work. Eject the cassette, turn off your camcorder, and leave it for about one hour with the cassette lid open. Your camcorder can be used again when both of the following conditions are met:

- The warning message does not appear when the power is turned on.
- Neither  nor  flashes when a cassette is inserted and the video operation buttons are pressed.

If moisture starts to condense, your camcorder sometimes cannot detect condensation. If this happens, the cassette is sometimes not ejected for 10 seconds after the cassette lid is opened. This is not a malfunction. Do not close the cassette lid until the cassette is ejected.

### ■ Note on moisture condensation

Moisture may condense when you bring your camcorder from a cold place into a warm place (or vice versa) or when you use your camcorder in a humid place as shown below.

- When you bring your camcorder from a ski slope into a place warmed up by a heating device.
- When you bring your camcorder from an air conditioned car or room into a hot place outside.
- When you use your camcorder after a squall or a shower.
- When you use your camcorder in a hot and humid place.

### ■ How to avoid moisture condensation

When you bring your camcorder from a cold place into a warm place, put your camcorder in a plastic bag and seal it tightly. Remove the bag when the air temperature inside the plastic bag has reached the surrounding temperature (after about one hour).



## Video head

If you play back a tape recorded in HDV format, the image and sound may freeze for a while (about 0.5 seconds).

This occurs if the HDV signals cannot be recorded or played back correctly because of dirt on the tape or video head. Depending on the cassette, this fairly infrequently occurs even if the cassette is brand new or is not used a lot.

If this freezing point is created while playing back, you can solve this problem and see the pictures by rewinding after slightly forwarding. Such a freezing point cannot be recovered if it was created while recording.

To prevent such a problem, use the Sony mini DV cassette.

- If the following problem occurs, clean the video heads for 10 seconds with the Sony DVM-12CLD cleaning cassette (optional).
  - Playback pictures do not move.
  - Playback pictures do not appear.
  - The sound breaks off.
  -   Dirty video head. Use a cleaning cassette.] appears on the screen during recording.
  - The following phenomenon occurs in HDV format.



The playback screen pauses.



The playback screen goes blank.  
(Solid blue screen)

- The following phenomenon occurs in DVCAM (DV) format.



Block-noise appears.





The playback screen goes blank.  
(Solid blue screen)

- The video heads will be worn after long use. If you cannot obtain a clear image even after using a cleaning cassette (optional), the video heads may be worn out. Please contact your Sony dealer or local authorized Sony service facility to have the video heads replaced.

### LCD screen

- Do not exert excessive pressure on the LCD screen, as it may cause damage.
- If your camcorder is used in a cold place, a residual image may appear on the LCD screen. This is not a malfunction.
- While using your camcorder, the back of the LCD screen may heat up. This is not a malfunction.

#### ■ To clean the LCD screen

If fingerprints or dust make the LCD screen dirty, it is recommended you use a soft cloth to clean it. When you use the LCD Cleaning Kit (optional), do not apply the cleaning liquid directly to the LCD screen. Use cleaning paper moistened with the liquid.

### On handling the casing

- If the casing is soiled, clean the camcorder body with a soft cloth lightly moistened with water, and then wipe the casing with a dry soft cloth.
- Avoid the following to avoid damage to the finish.
  - Using chemicals such as thinner, benzine, alcohol, chemical cloths, repellent, insecticide and sunscreen.
  - Handling with above substances on your hands.
  - Leaving the casing in contact with rubber or vinyl objects for a long period of time.

### About care and storage of the lens

- Wipe the surface of the lens clean with a soft cloth in the following instances:
  - When there are fingerprints on the lens surface.
  - In hot or humid locations
  - When the lens is exposed to salty air such as at the seaside.
- Store in a well-ventilated location subject to little dirt or dust.
- To prevent mold, periodically clean the lens as described above. It is recommended that you operate your camcorder about once a month to keep it in optimum state for a long time.

### On charging the pre-installed rechargeable battery

Your camcorder has a pre-installed rechargeable battery to retain the date, time, and other settings even when the POWER switch is set to OFF (CHG). The pre-installed rechargeable battery is always charged while your camcorder is connected to the wall socket via the AC Adaptor or while the battery pack is inserted. The rechargeable battery will be fully discharged in about **3 months** if you do not use your camcorder at all without the AC Adaptor connected or the battery pack attached. Use your camcorder after charging the pre-installed rechargeable battery.

However, even if the pre-installed rechargeable battery is not charged, the camcorder operation will not be affected as long as you are not recording the date.

#### ■ Procedures

Connect your camcorder to a wall socket using the supplied AC Adaptor, and leave it with the POWER switch set to OFF (CHG) for more than 24 hours.

## Removing dust from inside the viewfinder

---

### 1 Remove the viewfinder.

While sliding the viewfinder release lever to the left **1**, remove the viewfinder **2**.

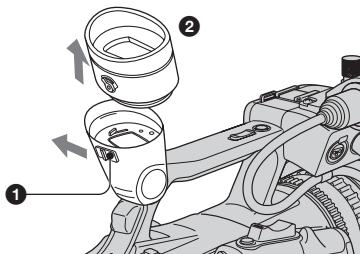

---

### 2 Remove dust from inside the viewfinder and the part shown below with a blower.

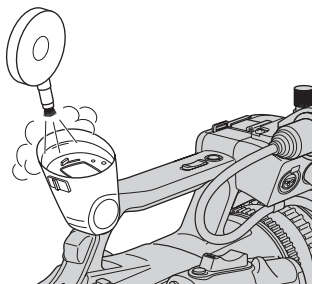

---

### 3 Attach the viewfinder following the reverse procedure of step 1.

---

# Specifications

## System

### Video recording system (HDV)

2 rotary heads, Helical scanning system

### Video recording system (DVCAM (DV))

2 rotary heads, Helical scanning system

### Still image recording system

Exif Ver. 2.2\*1

### Audio recording system (HDV)

Rotary heads, MPEG-1 Audio Layer-2,

Quantization: 16 bits

Fs48kHz (stereo)

transfer rate: 384 kbps

### Audio recording system (DVCAM (DV))

Rotary heads, PCM system

Quantization: 12 bits

Fs32kHz (channel 1/2 stereo),

Quantization: 16 bits



Fs48kHz (channel 1/2 stereo)

### Video signal

PAL color, CCIR standards

1080/50i specification

### Usable cassette

Mini DV cassette with the  mark printed or Mini DVCAM cassette with the  mark printed

### Tape speed (HDV)

Approx. 18.812 mm/s

### Tape speed (DVCAM)

Approx. 28.218 mm/s

### Tape speed (DV SP)

Approx. 18.812 mm/s

### Recording/playback time (HDV)

63 min (using a PHDVM-63DM cassette)

### Recording/playback time (DVCAM)

41 min (using a PHDVM-63DM cassette)

### Recording/playback time (DV SP)

63 min (using a PHDVM-63DM cassette)

### Fast forward/rewind time

Approx. 2 min 40 s (using a PHDVM-63DM cassette and rechargeable battery pack)

Approx. 1 min 45 s (using a PHDVM-63DM cassette and AC Adaptor)

### Viewfinder

Electric viewfinder (color, black and white)

### Image device

4.5 mm (1/4 type) 3CMOS sensor

Recording Pixels (HDV/DV16:9 still recording):

Max. 1.20 Mega (1 440 × 810) pixels \*2

Gross: Approx. 1 120 000 pixels

Effective (movie, 16:9):

1 037 000 pixels

Effective (movie, 4:3):

778 000 pixels

Effective (still, 16:9):

1 037 000 pixels

Effective (still, 4:3):

778 000 pixels

### Lens

Carl Zeiss Vario-Sonnar T\*

20 × (Optical), Approx. 30 × (Digital, when [D.EXTENDER] is set to [ON])

### Focal length

f=3.9 - 78 mm (5/32 ~ 3 1/8 in.)

When converted to a 35 mm still camera \*3

37.4 - 748 mm (1 1/2 ~ 29 1/2 in.) (16:9),

45.7 - 914 mm (1 13/16 ~ 36 in.) (4:3)

F1.6 - 2.8

Filter diameter: 62 mm (2 1/2 in.)

### Color temperature

Indoor (3 200 K),

Outdoor (5 800 K)

## Minimum illumination

4 lx (lux) (F 1.6)

\*1“Exif” is a file format for still images, established by the JEITA (Japan Electronics and Information Technology Industries Association). Files in this format can have additional information such as your camcorder’s setting information at the time of recording.

\*2Still image resolution is obtained by the unique pixel array of Sony’s ClearVid CMOS Sensor and image processing system (new Enhanced Imaging Processor).

\*3The focal length figures are actual figures resulting from wide angle pixel read out.

## Output connectors

### AUDIO/VIDEO output

10-pin connector

Video signal: 1 Vp-p, 75 Ω (ohms)

Luminance signal: 1 Vp-p, 75 Ω (ohms)

Chrominance signal: 0.3 Vp-p (burst signal), 75 Ω (ohms)

Audio signal: 461 mV (at load impedance 47 kΩ (kilohms)), Output impedance with less than 2.2 kΩ (kilohms)

### COMPONENT OUT jack

Y: 1 Vp-p, 75Ω (ohms), PB/PR, CB/CR:  
+/- 350 mV, 75 Ω (ohms)

### HDMI OUT jack

TypeA (19-pin)

## Input/Output connectors

### LANC jack

Stereo mini-minijack (Ø 2.5 mm)

### INPUT1/INPUT2 jack

XLR3-pin, female,  
-60 dBu: 3kΩ(kilohms)  
+4 dBu: 10kΩ(kilohms)  
(0 dBu=0.775 Vrms)

### USB jack

mini-B

### i HDV/DV jack

i.LINK interface (IEEE 1394, 4-pin connector S100)

## LCD screen

### Picture

8.8 cm (3.5 type, aspect ratio 16:9)

### Total dot number

211 200 (960 × 220)

## General

### Peak inrush current

Hot switching inrush current, measured in accordance with European standard EN55103-1: 5 A (230 V)

### Power requirements

DC 7.2 V (battery pack)

DC 8.4 V (AC Adaptor)

### Average power consumption\*

During camera recording using the viewfinder with normal brightness:

HDV recording 6.8 W

DVCAM (DV) recording 6.6 W

During camera recording using the LCD with normal brightness:

HDV recording 6.8 W

DVCAM (DV) recording 6.6 W

### Operating temperature

0 °C to + 40 °C (32 °F to 104 °F)

### Storage temperature

-20 °C to + 60 °C (-4 °F to + 140 °F)

### Dimensions (approx.)

145 × 184 × 431 mm

(5 3/4 × 7 1/4 × 17 in.) (w/h/d)

including the projecting parts

145 × 184 × 431 mm

(5 3/4 × 7 1/4 × 17 in.) (w/h/d)

## Specifications (Continued)

including the projecting parts with battery pack NP-F570

### Mass (approx.)

1.5 kg (3 lb 6 oz) main unit only

1.9 kg (4 lb 2 oz) including the NP-F570 rechargeable battery pack, cassette (PHDVM-63DM), and lens hood with lens cover, microphone

### Supplied accessories

See page 19.

\* When using the supplied microphone

## AC Adaptor AC-L15A

### Power requirements

AC 100 V - 240 V, 50/60 Hz

### Current consumption

0.35 - 0.18 A

### Power consumption

18 W

### Output voltage

DC 8.4 V\*

### Operating temperature

0 °C to 40 °C (32 °F to 104 °F)

### Storage temperature

-20 °C to +60 °C (-4 °F to +140 °F)

### Dimensions (approx.)

56 × 31 × 100 mm

(2 1/4 × 1 1/4 × 4 in.) (w/h/d)

excluding the projecting parts

### Mass (approx.)

190 g (6.7 oz) excluding the power cord

\* See the label on the AC Adaptor for other specifications.

## Rechargeable battery pack NP-F570

### Maximum output voltage

DC 8.4 V

### Output voltage

DC 7.2 V

### Capacity

15.8 Wh (2 200 mAh)

### Dimensions (approx.)

38.4 × 20.6 × 70.8 mm

(1 9/16 × 13/16 × 2 7/8 in.) (w/h/d)

### Mass (approx.)

100 g (3.5 oz)

### Operating temperature

0 °C to 40 °C (32 °F to 104 °F)

### Type

Lithium ion

Design and specifications are subject to change without notice.



## On trademarks

- “Memory Stick,”  “Memory Stick Duo,” “MEMORY STICK DUO,” “Memory Stick PRO Duo,” “MEMORY STICK PRO DUO,” “MagicGate,” “MAGICGATE,” “MagicGate Memory Stick” and “MagicGate Memory Stick Duo” are trademarks of Sony Corporation.
- “InfoLITHIUM” is a trademark of Sony Corporation.
- i.LINK and  are trademarks of Sony Corporation.
- Mini  is a trademark.
-  is a trademark.
- Microsoft, Windows, Windows Vista, and Windows Media are trademarks or registered trademarks of U.S. Microsoft Corporation in the U.S. and other countries.
- Macintosh and Mac OS are registered trademarks of Apple Inc. in the U.S. and other countries.
- HDV and the HDV logo are trademarks of Sony Corporation and Victor Company of Japan, Ltd.
- HDMI, HDMI logo, and High-Definition Multimedia Interface are trademarks or registered trademarks of HDMI Licensing LLC.
- Pentium is a trademark or registered trademark of Intel Corporation.
- Adobe, and Adobe Reader are trademarks of Adobe Systems Incorporated.

All other product names mentioned herein may be the trademarks or registered trademarks of their respective companies. Furthermore, <sup>TM</sup> and “®” are not mentioned in each case in this manual.



## Notes on the License

ANY USE OF THIS PRODUCT OTHER THAN CONSUMER PERSONAL USE IN ANY MANNER THAT COMPLIES WITH THE MPEG-2 STANDARD FOR ENCODING VIDEO INFORMATION FOR PACKAGED MEDIA IS EXPRESSLY PROHIBITED WITHOUT A LICENSE UNDER APPLICABLE PATENTS IN THE MPEG-2 PATENT PORTFOLIO, WHICH LICENSE IS AVAILABLE FROM MPEG LA, L.L.C., 250 STEELE STREET, SUITE 300, DENVER, COLORADO 80206.

# Identifying parts and controls

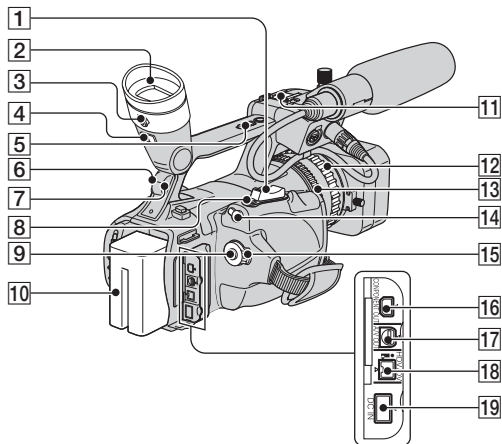
The numbers in ( ) are reference pages.



- |  |   |
|--|---|
| <b>1</b> Zoom lever (37)   | <b>12</b> Focus ring (38)   |
| <b>2</b> Viewfinder (26)   | <b>13</b> Zoom ring (37)  |
| <b>3</b> Viewfinder lens adjustment lever (26)   | <b>14</b>  LANC jack   |
| <b>4</b> Viewfinder release lever (133)  | The  LANC control jack is used for controlling the tape transport of video device and peripherals connected to it. |
| <b>5</b> Handle zoom lever (37)  | <b>15</b> POWER switch (25)   |
| <b>6</b> Remote sensor (back) (143)  | <b>16</b> COMPONENT OUT jack (58)   |
| <b>7</b> Rec lamp (back) (32)<br>The rec lamp flashes if the remaining tape or battery is low. | <b>17</b> A/V OUT jack (58)   |
| <b>8</b> PHOTO/EXPANDED FOCUS button (34)  | <b>18</b>  HDV/DV jack (58)  |
| <b>9</b> REC START/STOP button (32)  | <b>19</b> DC IN jack (22)   |
| <b>10</b> Battery pack (22)  |   |
| <b>11</b> Accessory shoe   |   |

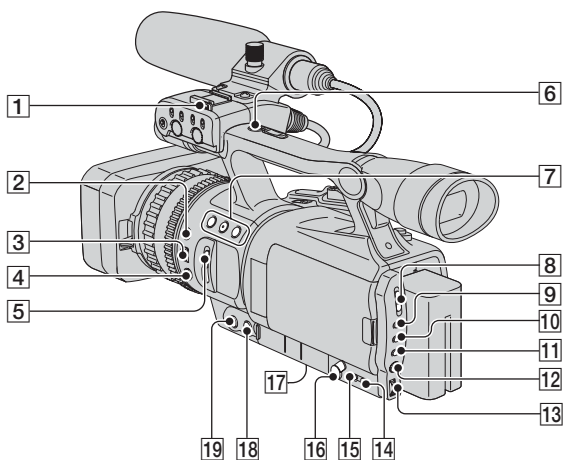

- 1** Hook for the shoulder strap (140)
- 2** EXPOSURE/IRIS button (39)
- 3** EXPOSURE/IRIS dial (39)
- 4** PUSH AUTO FOCUS button (38)
- 5** ND FILTER switch (1/2/OFF) (41)
- 6** REC START/STOP button (32)
- 7** ASSIGN buttons (1/2/3)\*(49)
- 8** AUTO LOCK switch
- 9** GAIN button (42)
- 10** SHUTTER SPEED button (42)
- 11** WHT BAL (white balance) button (43)
- 12** MENU button (64)
- 13** SEL/PUSH EXEC dial (28)
- 14** STATUS CHECK button (54)
- 15** PICTURE PROFILE button (44)
- 16** (headphones) jack  
When you use headphones, the speaker on your camcorder is silent.

- 17** Tripod receptacle  
Make sure that the length of the tripod screw is less than 5.5 mm (7/32 inch). Otherwise, you cannot attach the tripod securely, and it may damage your camcorder.

- 18** FOCUS button\* (38)
- 19** EXPANDED FOCUS button (39)

\* The ASSIGN button 2, FOCUS button, and SHUTTER SPEED button have raised tactile dots for your convenience in locating the buttons.

## Identifying parts and controls (Continued)

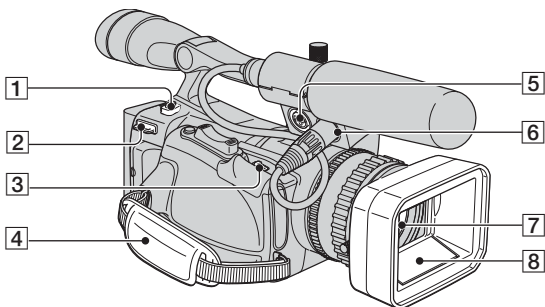

- 1 BATT RELEASE (battery release) button (23)
- 2 Hook for the shoulder strap (140)
- 3 OPEN/EJECT lever (30)
- 4 Grip belt (25)
- 5 INPUT2 jack (20)
- 6 INPUT1 jack (20)
- 7 Lens (14)
- 8 Lens hood with lens cover (21)

### To attach the shoulder strap

Attach the shoulder strap (optional) to the hooks for the shoulder strap.

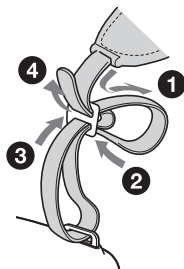

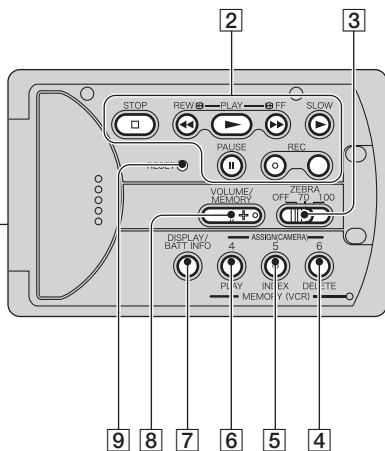
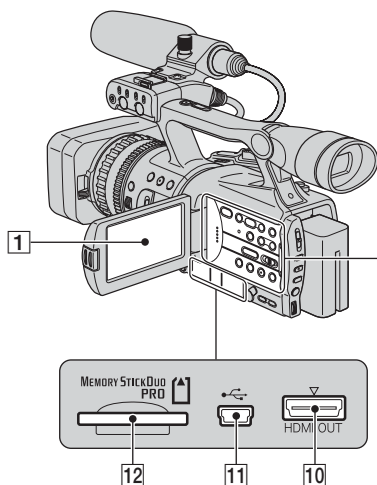

- 1 LCD screen (26)
- 2 Video control buttons (REW, PLAY\*, FF, PAUSE, STOP, SLOW, REC) (35)
- 3 ZEBRA switch (41)
- 4 ASSIGN 6, MEMORY/DELETE button (49, 99)
- 5 ASSIGN 5, MEMORY/INDEX button (35, 49)
- 6 ASSIGN 4, MEMORY/PLAY button (35, 49)
- 7 DISPLAY/BATT INFO button (54, 55)
- 8 VOLUME/MEMORY button\* (36)
- 9 RESET button  
If you press the RESET button, all settings including the clock setting (except the Picture profile and Camera profile settings) return to the default.
- 10 HDMI OUT jack (58)
- 11 USB jack (100)
- 12 “Memory Stick Duo” slot (30)

\* Each of the PLAY button, VOLUME/MEMORY button and MEMORY/INDEX button has a raised tactile dot (the INDEX

button has it on the + side). Use it to identify the location of the buttons.

### To attach the jack cover

Attach the jack cover as shown in the illustration.

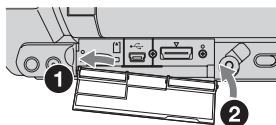

## Identifying parts and controls (Continued)

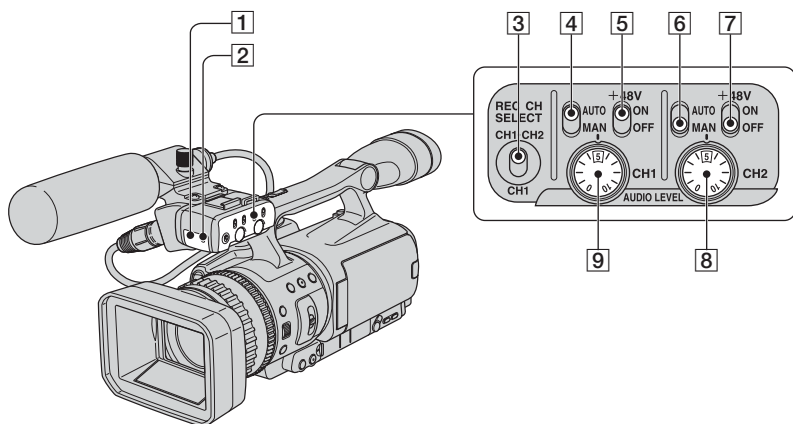

- 1** Remote sensor (front) (143)
- 2** Rec lamp (front)  
The rec lamp flashes if the remaining tape or battery is low.
- 3** REC CH SELECT switch (20)
- 4** CH1 AUTO/MAN switch (48)
- 5** CH1 +48V switch (48)
- 6** CH2 AUTO/MAN switch (48)
- 7** CH2 +48V switch (48)
- 8** CH2 AUDIO LEVEL dial (48)
- 9** CH1 AUDIO LEVEL dial (48)

## Remote Commander

Remove the insulation sheet before using the Remote Commander.

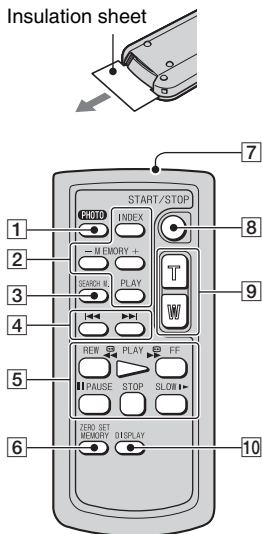

### 1 PHOTO (34)

The on-screen image when you press this button will be recorded onto the “Memory Stick Duo” as a still image.

### 2 Memory control buttons (Index, -/+, Memory/playback) (36)

### 3 SEARCH M. (56)

### 4 ◀▶▶▶

### 5 Video control buttons (Rewind, Playback, Fast-forward, Pause, Stop, Slow) (35)

### 6 ZERO SET MEMORY

This button is invalid with your camcorder.

### 7 Transmitter

### 8 START/STOP (32)

### 9 Power zoom (37)

### 10 DISPLAY (54)

## Notes

- Aim the Remote Commander towards the remote sensor to operate your camcorder.
- Point the remote sensor away from strong light sources such as direct sunlight or overhead lighting. Otherwise, the Remote Commander may not function properly.
- When you are operating with the Remote Commander supplied with your camcorder, your VCR may also operate. In that case, select a commander mode other than VTR 2 for your VCR, or cover the sensor of your VCR with black paper.

## To change the battery of the Remote Commander

- 1 While pressing on the tab, inset your fingernail into the slit to pull out the battery case.
- 2 Place a new battery with the + side facing up.
- 3 Insert the battery case back into the Remote Commander until it clicks.

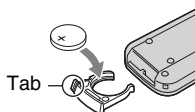

## WARNING

Battery may explode if mistreated. Do not recharge, disassemble or dispose of in fire.

- When the lithium battery becomes weak, the operating distance of the Remote Commander may shorten, or the Remote Commander may not function properly. In this case, replace the battery with a Sony CR2025 lithium battery. Use of another battery may present a risk of fire or explosion.

# Indicators for the LCD screen and viewfinder

The numbers in ( ) are reference pages.

The indicators will not be recorded on the tape during recording.

## Recording movies

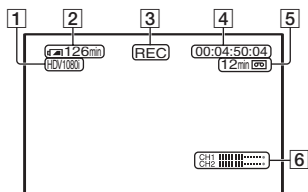

- 1 Recording format (HDV1080i or DVCAM, DV SP) (82)
- 2 Remaining battery (approx.)
- 3 Recording status ([STBY] (standby) or [REC] (recording))
- 4 During recording:  
Tape counter (hour: minute: second: frame)  
During playback:  
Time code (hour: minute: second: frame)
- 5 Recording capacity of the tape (approx.)
- 6 Audio level display (79)

## Recording still images

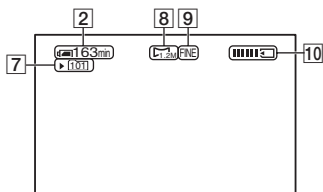

- 7 Recording folder (88)
- 8 Image size (87)
- 9 Quality ([FINE] or [STD]) (87)
- 10 Recording indicator (34)

## Data code during recording

The date/time during recording and the camera setting data will be recorded automatically. They do not appear on the screen during recording, but you can check them as [DATA CODE] during playback (80).



## Viewing movies

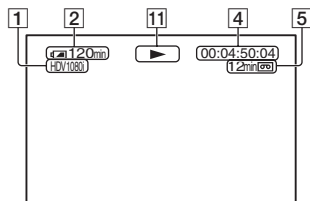



- 11** Tape transport indicator  
Recording mode (DVCAM or DV SP) appears when a tape recorded in the DVCAM or DV SP format is played back. DV.

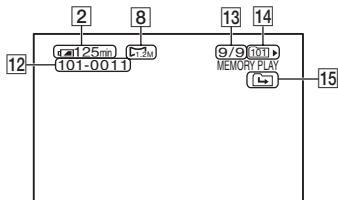

## Viewing still images



- 12** Data file name  
**13** Picture number/Total number of recorded pictures in the current playback folder  
**14** Playback folder (88)  
**15** Previous/Next folder icon  
The , ,  appear when the first or last picture of the current folder is displayed and when there are multiple folders on the same "Memory Stick Duo." You can move to Previous/Next folder with the VOLUME/ MEMORY button.

## Indicators for the LCD screen and viewfinder (Continued)

### Indicators when you made changes

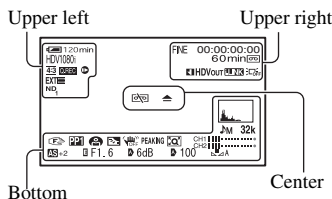

#### Upper left

Indicator	Meaning
HDV1080i	Recording format (82)
DVCAM DV SE	
4:3	DV WIDE REC (83)*
Q.REC	QUICK REC (90)**
⏸	DV FRAME REC (74)*
ND <sub>1</sub> ND <sub>2</sub> ND <sub>OFF</sub>	ND filter (41)
⏸	INTERVAL REC (73)
EXT EXT	EXT REC CTRL (83)

#### Upper right

Indicator	Meaning
FINE STD	Still Image quality (87)
■	INDEX MARK (50)
HDVIn DVIn	HDV input/ DV input (96)
HDVout DVout	HDV output/ DV output (95)
i.LINK	i.LINK connection (58, 92)
☒ OFF	LCD backlight off (26)

#### Center

Indicator	Meaning
⚠	Warning (117)

#### Bottom

Indicator	Meaning
	HISTOGRAM (78)
32k 48k	DV AU. MODE (DV Audio mode) (75)*
M	Manual volume control(48)
	Manual focus (38)
PP1 ~ PP6	Picture profile (44)
	SPOTLIGHT (74)
	Backlight (74)
	SteadyShot off (70)
PEAKING	PEAKING (77)
	D.EXTENDER (74)
AS	AE SHIFT (71)
E	EXPOSURE/IRIS dial control (39)
A	Auto setting (79)
	White balance (43)
25pSCAN	PROG. SCAN (70)
MACRO OFF	FOCUS MACRO (71)
HYPER	HYPHER GAIN (74)

\* The settings can be made only for the pictures in the DVCAM (DV) format.

\*\* The setting can be made only for the pictures in the HDV format.

# Index

## Numeric

1080i/576i.....	83
16:9 (wide) or 4:3 TV.....	58
21-pin adaptor.....	63
+48V switch.....	20, 48, 142
576i.....	83

## A

AC Adaptor.....	22
Access lamp.....	31
AE RESPONSE.....	71
AE SHIFT.....	40, 71, 111
AF ASSIST.....	71
AGC LIMIT.....	71
ALL ERASE.....	87
ALL FILES.....	87
ALLSCAN MODE.....	79, 111
ASPECT.....	78
ASSIGN BTN.....	90
ASSIGN buttons.....	49
AT IRIS LMT.....	71
ATW SENS.....	72
AUDIO CH SEL.....	77
AUDIO LEVEL dial.....	48
AUDIO SET menu.....	75
AUTO LOCK switch.....	40
AUTO/MAN switch.....	48
AU. MAN GAIN.....	75
AU.LVL DISP (Audio level display).....	79
A/V connecting cable.....	60, 92
A/V connecting cable with S VIDEO.....	63, 92
A/V OUT jack.....	60

## B

BACK LIGHT.....	74, 111
BAR.....	79
BATT RELEASE (battery release) button.....	23

Battery	
Battery Info.....	55
Battery pack.....	22
BEEP.....	91
BLACK FADER.....	75
BLK COMPNSTN.....	46
Button-type lithium battery .....	143

## C

Cable holder.....	20
CAM DATA DSP (Camera data display).....	79
CAMERA DATA.....	81
CAMERA PROF. (Camera profile).....	89, 111
CAMERA SET menu.....	69
Cassette	
Insert/Eject.....	30
Tape.....	121
Cassette compartment.....	30
CD-ROM Manual.....	18
CH1.....	20
CH1 AUDIO LEVEL dial....	48
CH1 AUTO/MAN switch....	48
CH2.....	20
CH2 AUDIO LEVEL dial....	48
CH2 AUTO/MAN switch....	48
CHARGE lamp.....	22
Charging time.....	23
CINEMA.....	44
CINEMA TONE COLOR....	46
CINEMATONE GAMMA .....	46
CLOCK SET.....	28, 90
CNTRST ENHCR.....	70, 111
COLOR BAR.....	70
COLOR LEVEL.....	45
COLOR PHASE.....	45
COMPONENT.....	83
COMPONENT OUT jack....	60
Component video cable.....	60

Computer.....	102
Connect	
TV.....	58
VCR.....	92
COPY.....	46
CURRNT FOLDER.....	87

## D

DATA CODE.....	80
DATE.....	80
Date and time.....	29, 144
DATE REC.....	91, 111
Date search.....	56
DC IN jack.....	22
DC plug.....	22
DEGREE.....	80
Deleting camera profile settings .....	90
Deleting recorded pictures .....	99
DIAL ASSIGN.....	69
DIAL ROTATE.....	69
DIAL SENS.....	69
DISP OUTPUT.....	81
DISPLAY SET menu.....	77
DISPLAY/BATT INFO button.....	26, 54, 55
DOWN CONVERT.....	84
DRUM RUN.....	91
Dubbing.....	92
DV.....	82
DV AUDIO MIX.....	77
DV AU. MODE (DV Audio mode).....	75
DV format.....	82
DV FRAME REC.....	74
DV REC MODE (Recording mode).....	82
DV SP.....	83
DV WIDE REC.....	83
DVCAM.....	82

## Index (Continued)

D.EXTENDER  
(Digital Extender).....74, 111

## E

EDGE CROP.....84  
End search.....51  
END TRIGGER.....69  
Expanded focus.....39  
EXPOSURE.....39  
EXPOSURE1.....39  
EXPOSURE2.....40  
EXPOSURE/IRIS.....39, 69  
EXPOSURE/IRIS button.....39  
EXPOSURE/IRIS dial.....39  
EXP.FOCUS TYPE.....78  
EXT REC CTRL.....83

## F

FADER.....75  
FILE NO. (File number).....88  
FINE.....87  
FLCKR REDUCE.....72  
Focus.....38  
FOCUS button.....38  
FOCUS DISP.....79  
FOCUS INFNTY.....50  
FOCUS MACRO.....71  
Focus ring.....38  
Folder  
    NEW FOLDER.....88  
    PB FOLDER (Playback  
    folder).....88  
    REC FOLDER (Recording  
    folder).....88  
FORMAT.....88  
FREE RUN.....85  
FS32K.....75  
FS48K.....75

## G

Gain.....42

GAIN button.....42  
Grip belt.....25  
GUIDEFAME.....78

## H

HANDLE ZOOM.....72  
Handle zoom.....37  
HD (high definition) image  
quality.....58  
HDMI cable.....61  
HDMI OUT jack.....60  
HDV.....82  
HDV format.....120  
HDV1080i.....82  
HDV/DV interface.....82  
Headphones jack.....139  
High definition TV.....58  
HISTOGRAM.....78, 111  
Hook for the shoulder strap  
.....139, 140  
HOURS METER.....91  
HYPER GAIN.....74

## I

INDEX MARK.....50  
Index screen.....36  
Index search.....56  
Index signal.....50  
Indicators.....146  
Indoor.....43  
“InfoLITHIUM” battery pack  
.....127  
INPUT1.....20, 48  
INPUT1 LEVEL.....76  
INPUT1 TRIM.....76  
INPUT1 WIND.....76  
INPUT2.....20, 48  
INPUT2 LEVEL.....76  
INPUT2 TRIM.....76  
INPUT2 WIND.....76  
Insulation sheet.....143

INTELLIGENT.....72  
INTERVAL.....73  
INTERVAL REC.....73, 111  
IN/OUT REC menu.....82  
IRIS.....40  
i.LINK.....128  
i.LINK cable.....61, 96, 105  
i.LINK CONV.....59, 84

## J

Jack cover.....30  
JPEG.....125

## K

KNEE POINT.....46

## L

LANC jack.....138  
LANGUAGE.....90  
Large eyecup.....27  
Last scene review.....51  
LAST SCN RVW.....51  
LCD.....26  
LCD backlight.....26  
LCD BL LEVEL.....80  
LCD BRIGHT.....80  
LCD COLOR.....80  
Lens hood fixing screw.....21  
Lens hood with lens cover...21  
LETTER BOX.....84  
LETTER SIZE.....81  
LINE.....76  
LINEAR.....72  
LINKED.....75

## M

Macintosh.....102  
Maintenance.....130  
MARKER.....78, 111  
MEMORY A.....43  
MEMORY B.....43

MEMORY SET menu .....	87
Memory Stick .....	12, 90, 125
Memory Stick Duo .....	30, 125
Insert/Eject.....	30
Number of recordable pictures .....	87
Write-protect tab.....	125
Memory Stick Duo adaptor .....	126
“Memory Stick Duo” slot .....	31
“Memory Stick PRO Duo” .....	126
MEMORY/DELETE button .....	99
MEMORY/INDEX button .....	35
MEMORY/PLAY button .....	35
Menu	
AUDIO SET menu .....	75
CAMERA SET menu.....	69
DISPLAY SET menu.....	77
IN/OUT REC menu.....	82
MEMORY SET menu .....	87
Menu items .....	66
OTHERS menu.....	89
TC/UB SET menu .....	85
Using the menu.....	64
MENU button .....	28
Menu items .....	66
MIC.....	76
MIC NR .....	75
Microphone.....	20
Microphone holder.....	20
Mirror mode.....	33
MIX .....	77
Moisture condensation.....	130
MONOTONE .....	44
MPEG2 .....	107
<b>N</b>	
ND filter.....	41
NEW FOLDER.....	88

NTSC .....	113, 120
NUMBER.....	79

## O

One push auto focus.....	38
OPEN button .....	26
OPEN/EJECT lever.....	30
OPERATION .....	91
OTHERS menu .....	89
Outdoor .....	43
Outside power source.....	24

## P

PAL .....	120
PB FOLDER (Playback folder).....	88
PB ZOOM (Playback zoom) .....	90
PEAKING .....	77
PHOTO/EXPANDED FOCUS button .....	32
PHOTO/EXP.FOCUS .....	90
PictBridge.....	100
PictBridge PRINT .....	90
Picture profile.....	44
PICTURE PROFILE button .....	44
Picture Search .....	36
PLAY button .....	35
Playback .....	35
Playing time .....	24
PORTRAIT .....	44
Power cord .....	22
POWER switch .....	25
Pre-installed rechargeable battery.....	132
PRESET .....	85
Print.....	100
Printing recorded images ...	100
PROFILE NAME.....	46
PROG. SCAN .....	70

PUSH AUTO FOCUS button.....	38
-----------------------------	----

## Q

QUALITY .....	87
QUICK REC.....	90

## R

REC CH SELECT switch.....	20
REC CTL MODE .....	83, 111
REC FOLDER (Recording folder) .....	88
REC FORMAT.....	82
Rec lamp .....	32
REC LAMP (Recording lamp) .....	91
REC PAUSE.....	83
Rec review .....	51
REC RUN.....	85
REC START/STOP button .....	32
REC TIME.....	69, 73
REC TIMING .....	69
Recording .....	32
Recording time .....	23
REGENERATE.....	85
RELAY .....	83
REMAINING .....	81
Remaining battery .....	55
Remote Commander.....	143
REMOTE CTRL (Remote control) .....	91
RESET.....	46, 85
RESET button.....	141

## S

S VIDEO jack.....	58, 92
SAFETY ZONE .....	78
SD (standard definition) image quality .....	58
SEARCH M.....	56
Self-diagnosis display.....	117

## Index (Continued)

- SEL/PUSH EXEC dial .....28  
SEPARATE.....75  
SHARPNESS .....45  
SHOT TRANS .....52, 72  
Shot transition.....52  
Shoulder strap.....140  
SHUTTER DISP .....79  
Shutter speed .....42  
SHUTTER SPEED button.....42  
SKINTONE DTL .....45  
SKINTONE LVL .....45  
Skip Scan .....36  
SMTH SLW REC  
(Smooth slow recording) .....69  
SOFT STOP .....72  
SOFT TRANS .....72  
Specifications .....134  
SPOTLIGHT .....74  
SQUEEZE .....84  
STANDARD .....87  
START TRIGGR .....69  
Status check .....54  
STATUS CHECK button .....54  
STBY COMMAND .....83  
STEADYSHOT .....70  
Still images .....34  
STOP .....83  
SUNSET .....44  
Supplied items .....19  
SYNCHRONOUS .....83  
System Requirements  
    Macintosh.....102  
    Windows .....102
- T**  
Tape counter .....144  
TAPE RUN.....91  
Tape.....See Cassette  
TC .....86  
TC LINK .....85  
TC MAKE .....85  
TC PRESET .....85  
TC RUN .....85  
TC/UB DISP .....86  
TC/UB SET menu.....85  
Telephoto .....37  
THREADING .....91  
Time code .....144  
TONE.....71  
Trademark .....137  
TRANS CURVE.....72  
TRANS TIME.....72  
Transmitter .....143  
Tripod receptacle .....139  
Troubleshooting .....108  
TV .....58  
TV color systems .....120
- U**  
UB PRESET .....85  
UB TIME REC .....86  
U-BIT .....86  
USB cable .....100, 102  
USB jack .....100, 102  
USB SELECT .....90  
Using the menu items .....64  
Using your camcorder abroad  
    .....120
- V**  
VCR HDV/DV .....82  
VF B.LIGHT .....80  
VF COLOR.....80  
VF POWER MODE.....80  
Video control buttons.....141  
Video head .....131  
Viewfinder .....26  
Viewfinder lens adjustment  
    lever .....26  
Viewfinder release lever ....138  
Volume.....36, 48  
VOLUME/MEMORY button  
    .....35  
V-OUT/PANEL .....81
- W**  
Warning indicators .....117  
Warning messages.....118  
WB SHIFT .....45  
White balance.....43  
WHITE FADER.....75  
WHT BAL button.....43  
Wide angle.....37  
WIDE CONV. ....70  
Wind screen.....20  
Windows.....102  
WORLD TIME .....90  
Write-protect tab .....121, 125
- X**  
XLR SET .....75
- Z**  
Zebra.....42  
ZEBRA switch .....42  
Zoom .....37  
ZOOM DISPLAY .....79  
Zoom lever .....37  
Zoom ring.....37

